

# ***THOMSON***

---



[tv.mythomson.com](https://tv.mythomson.com)



[tv.mythomson.com/  
en/Support/FAQs/](https://tv.mythomson.com/en/Support/FAQs/)

# SMART TV

## IMPORTANT

Please read this manual carefully before installing and operating the TV.

Keep this manual handy for further reference.

### Contents

1	Safety Information .....	5
1.1	Markings on the product.....	6
1.2	Warning.....	6
1.3	Wall mounting warnings.....	7
1.4	Simplified EU declaration of conformity.....	7
1.5	Apps and performance.....	7
1.6	Data protection .....	8
2	Introduction and stand installation .....	8
2.1	Unpacking and installation .....	8
3	TV buttons and connections.....	9
3.1	TV button.....	10
3.2	Connections.....	11
4	Remote Control.....	12
5	TV installation .....	13
5.1	Set your TV.....	13
5.2	Connect antenna and power.....	13
6	Initial setup .....	14
6.1	Pairing Bluetooth remote .....	14
6.2	Language selection.....	15
6.4	TV setup option.....	16
6.4.1	Set up Google TV.....	17
6.4.2	Set up basic TV.....	23
7	Tuner mode .....	27
7.1	Aerial.....	27
7.2	Cable.....	28
7.3	Satellite.....	29
7.3.1	Antenna type.....	30

8	Home screen .....	31
8.1	Google Account .....	33
8.2	Apps.....	34
8.3	Library .....	34
8.4	Google TV search .....	35
8.5	Notifications .....	36
9	Settings.....	36
9.1	Set your device name.....	37
9.2	Channels and inputs.....	37
9.2.1	Channels.....	38
9.2.2	Inputs .....	41
9.3	Display and sound.....	42
9.3.1	Picture .....	42
9.3.2	Sound.....	44
9.3.3	Audio output.....	45
9.4	Network & Internet.....	45
9.4.1	Wi-Fi On/Off.....	45
9.4.2	Choose available Wi-Fi network.....	46
9.4.3	Other options.....	46
9.4.4	Ethernet options.....	46
9.4.5	Others .....	46
9.5	Accounts and sign-in .....	47
9.6	Privacy.....	47
9.7	Apps.....	48
9.8	System.....	49
9.8.1	Accessibility.....	49
9.8.2	About.....	50
9.8.3	Date and time .....	50
9.8.4	Language .....	50
9.8.5	Keyboard.....	50
9.8.6	Storage .....	50
9.8.7	Ambient mode.....	51

9.8.8	Power and energy.....	51
9.8.9	Cast .....	52
9.8.10	Google .....	52
9.8.11	System sounds.....	52
9.8.12	Retail mode.....	52
9.8.13	Restart.....	52
9.9	Remote and accessories.....	52
10	MMP – Multimedia Player.....	53
11	LIVE TV.....	55
11.1	Channels.....	56
11.1.1	Electronic Program Guide (EPG) .....	56
11.1.2	Channel.....	57
11.1.3	Channel management.....	57
11.2	TV Options .....	59
11.2.1	Source .....	59
11.2.2	Picture .....	59
11.2.3	Screen .....	59
11.2.4	Sound .....	59
11.2.5	Power.....	59
11.2.6	Parental controls .....	60
11.2.7	CI card.....	60
11.2.8	Advanced options:.....	60
11.2.9	Settings.....	61
12	Channel list option .....	61
12.1	Channel operation.....	61
12.2	Select type.....	62
12.3	Add favorite .....	63
13	Troubleshooting .....	64
14	Technical specifications .....	64
14.1	Country restrictions .....	64
14.2	Licenses .....	65

# 1 Safety Information



In extreme weather (storms, lightning) and long inactivity periods (going on holiday) disconnect the TV set from the mains.

The mains plug is used to disconnect the TV set from the mains and therefore it must remain readily operable. If the TV set is not disconnected electrically from the mains, the device will still draw power for all situations even if the TV is in standby mode or switched off.

**Note:** Follow the onscreen instructions for operating the related features.

**Important:** Please read these instructions fully before installing or operating the TV.

## WARNING

**This device is intended to be used by persons (including children) who are capable / experienced of using such a device unsupervised, unless they have been given supervision or instruction concerning the use of the device by a person responsible for their safety.**

- Use this TV set at an altitude of less than 2000 meters above sea level, in dry locations and in regions with moderate or tropical climates.
- The TV set is intended for household and similar general use but may also be used in public places.
- For ventilation purposes, leave at least 10cm of free space around the TV.
- The ventilation should not be impeded by covering or blocking the ventilation openings with items, such as newspapers, tablecloths, curtains, etc.
- The power cord plug should be easily accessible. Do not place the TV, furniture, etc. on the power cord. A damaged power cord/plug can cause fire or give you an electric shock. Handle the power cord by the plug, do not unplug the TV by pulling the power cord. Never touch the power cord/plug with wet hands as this could cause a short circuit or electric shock. Never make a knot in the power cord or tie it with other cords. When damaged it must be replaced, this should only be done by qualified personnel.
- Do not expose the TV to dripping or splashing of liquids and do not place objects filled with liquids, such as vases, cups, etc. on or over the TV (e.g., on shelves above the unit).
- Do not expose the TV to direct sunlight and do not place open flames such as lit candles on the top of or near the TV.
- Do not place any heat sources such as electric heaters, radiators, etc. near the TV set.
- Do not place the TV on the floor or inclined surfaces.
- To avoid danger of suffocation, keep plastic bags out of reach of babies, children and domestic animals.
- Carefully attach the stand to the TV. If the stand is provided with screws, tighten the screws firmly to prevent the TV from tilting. Do not over-tighten the screws and mount the stand rubbers properly.
- Do not dispose of the batteries in fire or with hazardous or flammable materials.

## WARNING

- Batteries must not be exposed to excessive heat such as sunshine, fire or the like.
- Excessive sound pressure from earphones or headphones can cause hearing loss.

**ABOVE ALL - NEVER let anyone, especially children, push or hit the screen, push anything into holes, slots or any other openings in the case.**

## 1.1 Markings on the product

The following symbols are used on the product as a marker for restrictions and precautions and safety instructions. Each explanation shall be considered where the product bears related marking only. Note such information for security reasons.



Class II Equipment: This appliance is designed in such a way that it does not require a safety connection to electrical earthing.



This marking indicates that this product should not be disposed with other household wastes throughout the EU. Please recycle it responsibly to promote the sustainable reuse of material resources. To return your used device, please use the return and collection systems or contact the retailer where the product was purchased.

## 1.2 Warning

Do not ingest the battery, due to Chemical Burn Hazard. This product or the accessories supplied with the product may contain a coin/button cell battery. If the coin/button cell battery is swallowed, it can cause severe internal burns in just 2 hours and can lead to death.

Keep new and used batteries away from children. If the battery compartment does not close securely, stop using the product and keep it away from children.

If you think batteries might have been swallowed or placed inside any part of the body, seek immediate medical attention.

A television may fall, causing serious personal injury or death. Many injuries, particularly to children, can be avoided by taking simple precautions such as:

- ALWAYS use cabinets or stands or mounting methods recommended by the manufacturer of the television set.
- ALWAYS use furniture that can safely support the television set.
- ALWAYS ensure the television set is not overhanging the edge of the supporting furniture.
- ALWAYS educate children about the dangers of climbing on furniture to reach the television set or its controls.
- ALWAYS route cords and cables connected to your television so they cannot be tripped over, pulled or grabbed.
- NEVER place a television set in an unstable location.

- NEVER place the television set on tall furniture (for example, cupboards or bookcases) without anchoring both the furniture and the television set to a suitable support.
- NEVER place the television set on cloth or other materials that may be located between the television set and supporting furniture.
- NEVER place items that might tempt children to climb, such as toys and remote controls, on top of the television or furniture on which the television is placed on.
- The equipment is only suitable for mounting at heights  $\leq 2$  m.

If the existing television set is going to be retained and relocated, the same considerations as above should be applied.

Apparatus connected to the protective earthing of the building installation through the mains connection or through other apparatus with a connection to protective earthing – and to a television distribution system using coaxial cable, may in some circumstances create a fire hazard. Connection to a television distribution system has therefore to be provided through a device providing electrical isolation below a certain frequency range (galvanic isolator).

### **1.3 Wall mounting warnings**

- Read the instructions before mounting your TV on the wall.
- The wall mount kit is optional. You can obtain it from your local dealer if it is not supplied with your TV.
- Do not install the TV on the ceiling or on an inclined wall.
- Use the specified wall mounting screws and other accessories.

Tighten the wall mounting screws firmly to prevent the TV from falling. Do not overtighten the screws.

Figures and illustrations in this user manual are provided for reference only and may differ from the actual product appearance. Product design and specifications may be changed without notice.

### **1.4 Simplified EU declaration of conformity**

Hereby, StreamView GmbH declares that the radio equipment type product device Smart TV is complying with Directive 2014/53/EU.

### **1.5 Apps and performance**

Download speed depends on your Internet connection. Some apps might not be available in your country or region. Netflix is available in selected countries:

<https://help.netflix.com/node/14164> Streaming membership is required. More information at [www.netflix.com](http://www.netflix.com). The availability of the language for Google Assistant depends on Google Voice Search support.

## 1.6 Data protection

The application providers and the providers of the services may collect and use technical data and related information, including but not limited to technical information about this device, system and application software and peripherals. They may use such information to improve products or to provide services or technologies which do not personally identify you.

Additionally, some third-party services, already provided in the device or installed by you after purchasing the product, may request a registration with your personal data. Some services may collect personal data without providing additional warnings. StreamView GmbH cannot be held liable for a possible breach of data protection by third-party services.

## 2 Introduction and stand installation

Thank you for choosing our product. You'll soon be enjoying your new TV. Please read these instructions carefully. They contain important information which will help you get the best from your TV and ensure safe and correct installation and operation.

### 2.1 Unpacking and installation

Take out the feet and the TV from the packing and put the feet onto a table or any other even surface.

- Use a flat and firm table or similar even surface that can support the weight of the TV.
- Do not hold the TV on the screen panel.
- Make sure not to scratch or break the TV.
- The feet are marked left and right.

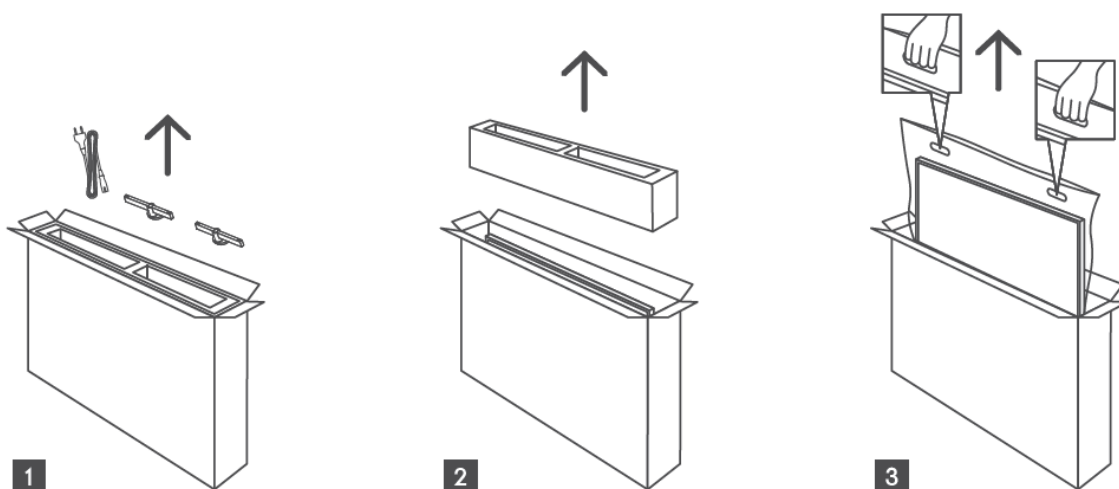

\*For 24" and 32" TV models two different feet installation positions are available.



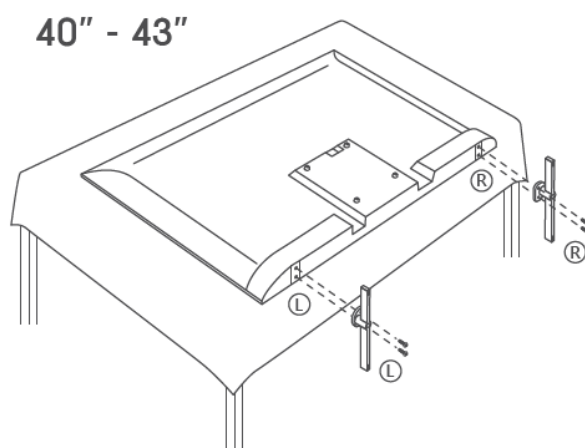
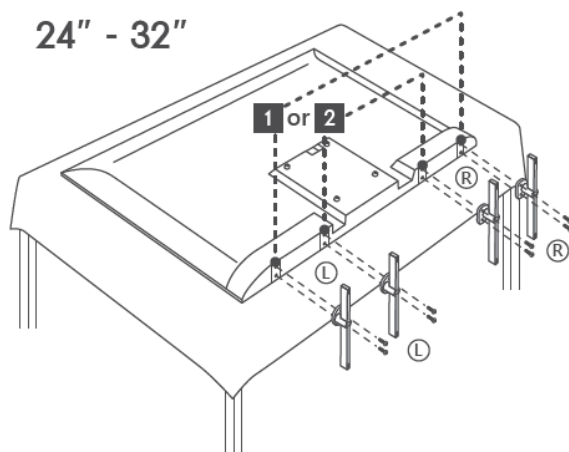

Your TV is prepared for a VESA-compliant wall mount bracket. This is not supplied with your TV. Contact your local dealer to purchase the recommended wall mount bracket. Holes and measurements for wall mount bracket installation:

	W (mm)	H (mm)	D (mm)	L (mm)
24"	100	100	4 (M4)	6
32"	100	100	6 (M6)	8
40"	200	200	6 (M6)	8
43"	200	200	6 (M6)	8

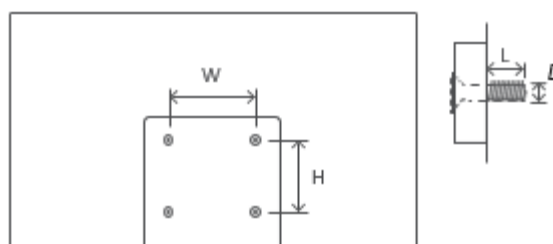

### 3 TV buttons and connections

**Caution:**



If you want to connect a device to the TV, make sure that both the TV and the device are turned off before making any connection. After the connection is done, you can turn on the units and use them.



Do not touch or be close to the HDMI, USB terminals, and prevent electrostatic discharge to disturb these terminals while in USB operation mode, or it will cause the TV to stop working or cause an abnormal status.

**Note:**

The actual position and arrangement of ports may be different from model to model.

### 3.1 TV button

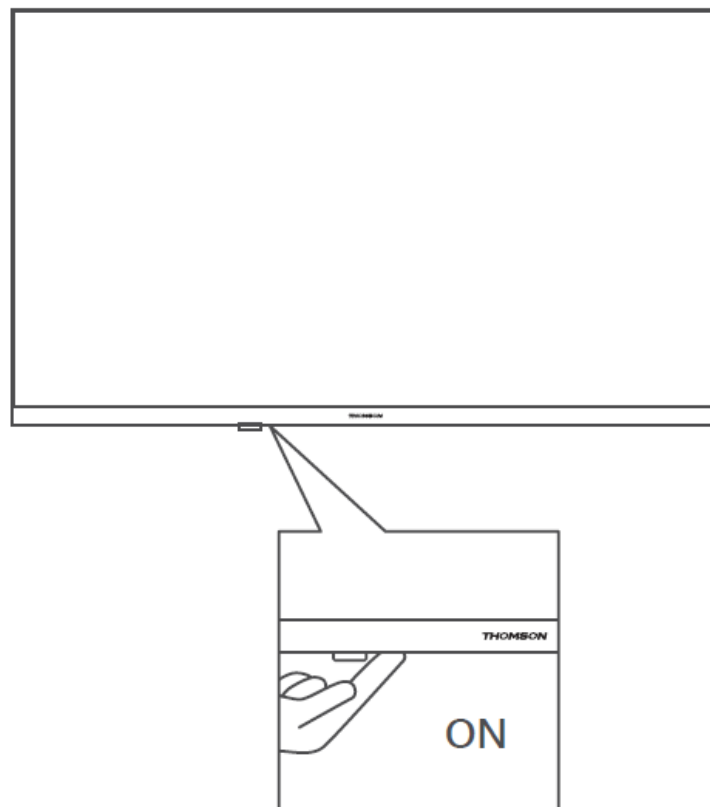

Press this button in standby mode to turn on / off the TV.



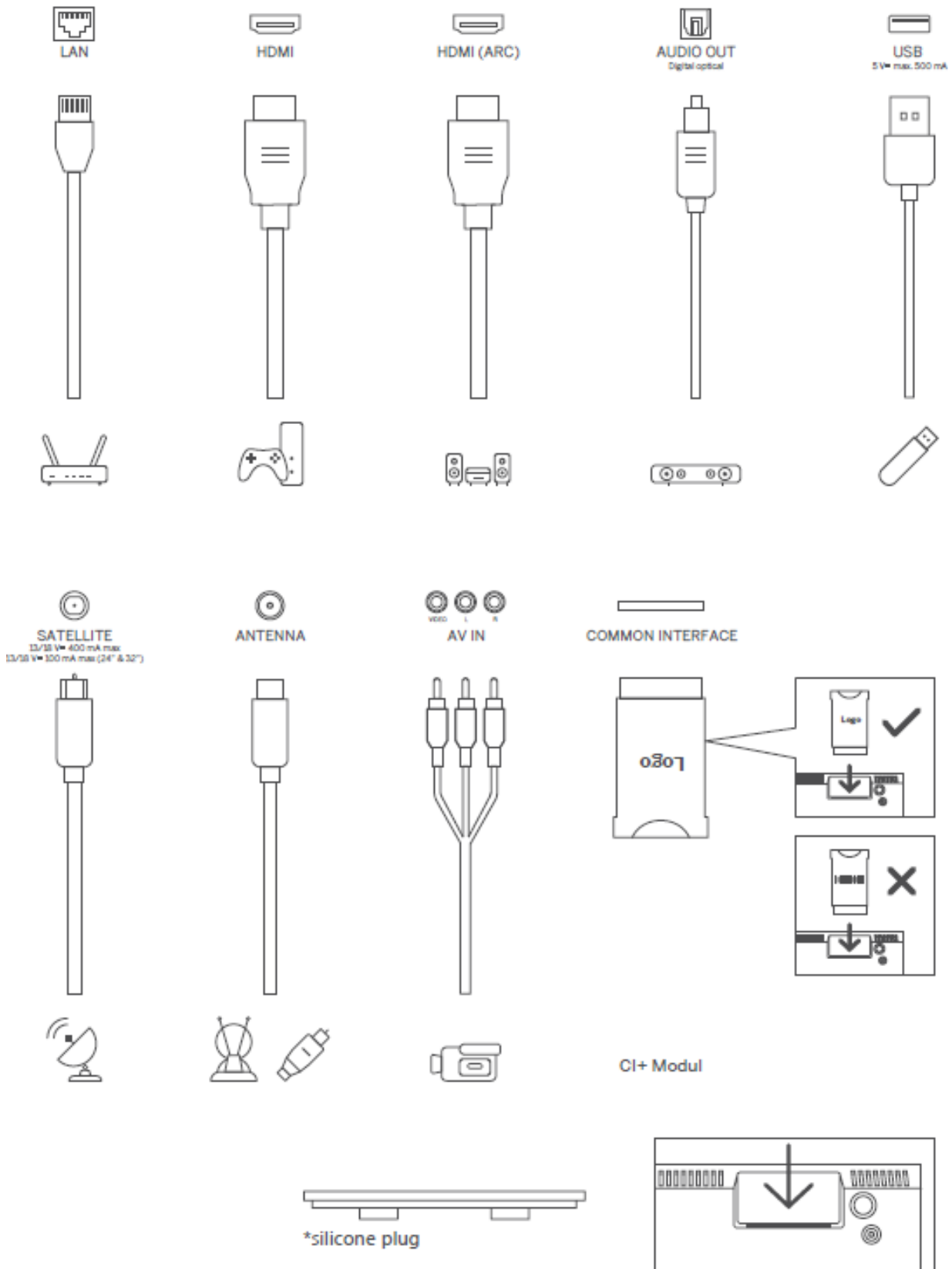





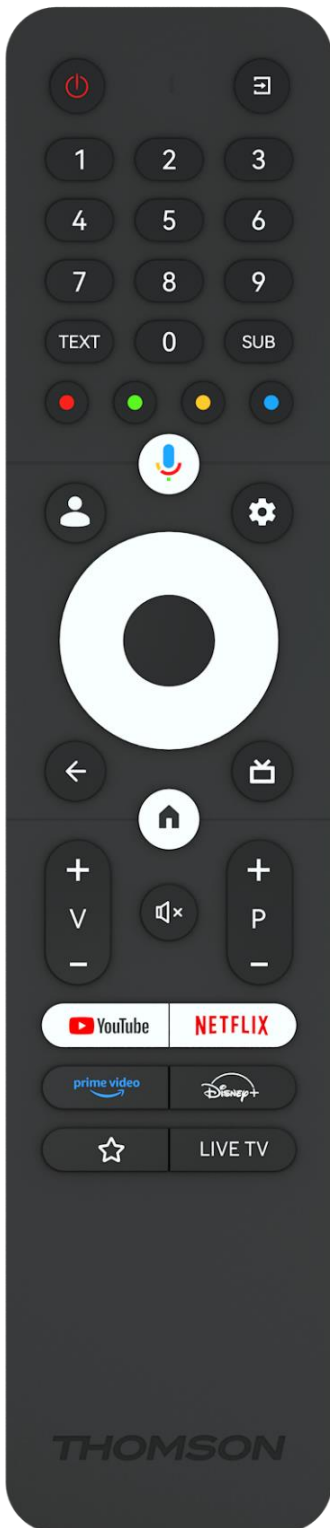







## 3.2 Connections



Note: If the model has a CI card slot on the top, a silicone plug for the CI card slot can be found in the accessory bag (for models without CI card slot, there is no such silicone plug), please insert the silicone plug into the slot when the CI card is not in use.

## 4 Remote Control



	Power button/Standby: Quick Standby / Standby / On
	Source/Input: Select the input of the TV
0-9	Numeric buttons: Switch the channel in Live TV mode, enter a number or a letter in the text box on the screen
TEXT	Open and close teletext (where available in Live TV mode)
SUB	Turn subtitles on and off (where available)
	Colored Buttons: Follow the on-screen instructions for colored button functions
	Microphone: Activate the Google Assistant
	Profile Switch: Switch between multiple Google profiles
	Settings: Display Live TV Settings menu (in Live TV mode), display available setting options such as sound and picture
	Directional buttons: Navigate menus, setting options, move the focus or cursor etc. and display the subpages in Live TV-Teletext mode when pressed Right or Left. Follow the on-screen instructions
	OK: Confirm selections, enter sub-menus, view channel list (in Live TV mode). Press 5 sec. to switch the backlight of the remote control on/off
	Back/Return: Return to previous menu screen, go one step back, close windows, close teletext (in Live TV-Teletext mode). Exit the playback of multimedia files and return to the MMP (Multi Medi Player) overview menu
	Electronic program guide
	Home: Open the Home Screen
+ v -	Volume +/-: Control the Sound Volume of the TV.
	Mute: Completely turn off the volume of the TV
+ P -	Programs +/-: Switch between TV/radio channels. Scroll the channel list page by page when the channel list is displayed on the TV screen.
	Launch the YouTube application
	Launch the Netflix application
	Launch the Prime Video application
	Launch the Disney + application
	Choose and set your favorite apps for easier access.
LIVE TV	Launch the Live TV application

## 5 TV installation

### 5.1 Set your TV

Put your TV on a firm place which can handle the weight of the TV. To avoid danger, please do not position the TV near water or heat sources (such as light, candle, heater), do not block the ventilation at the back of the TV.

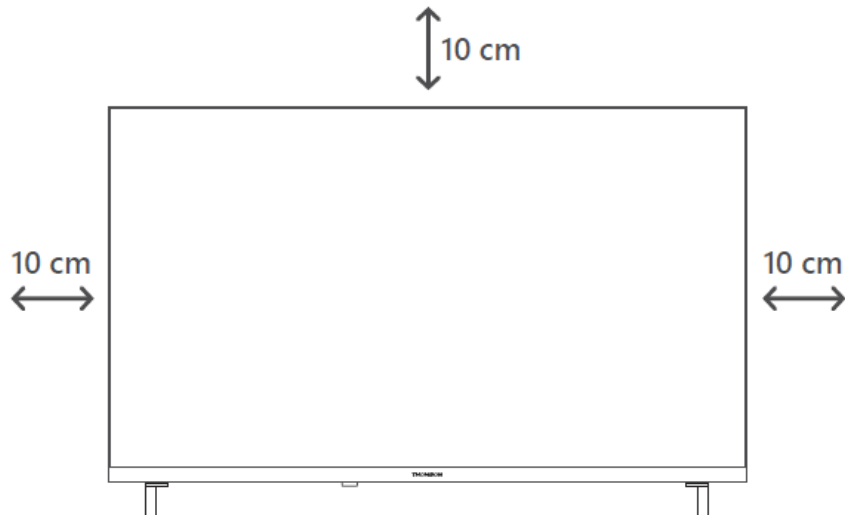

### 5.2 Connect antenna and power

1. Connect the antenna cable to the antenna socket on the back of the TV.
2. Plug in the power cord of your TV (AC 100-240 V~ 50/60 Hz). The TV enters standby mode (red light).
3. Turn on your TV by pressing the power button of the TV or the power button on the remote control.
4. In case you have purchased a TV model with 12 Volt adapter included - use the right port to connect the adapter to the TV set.

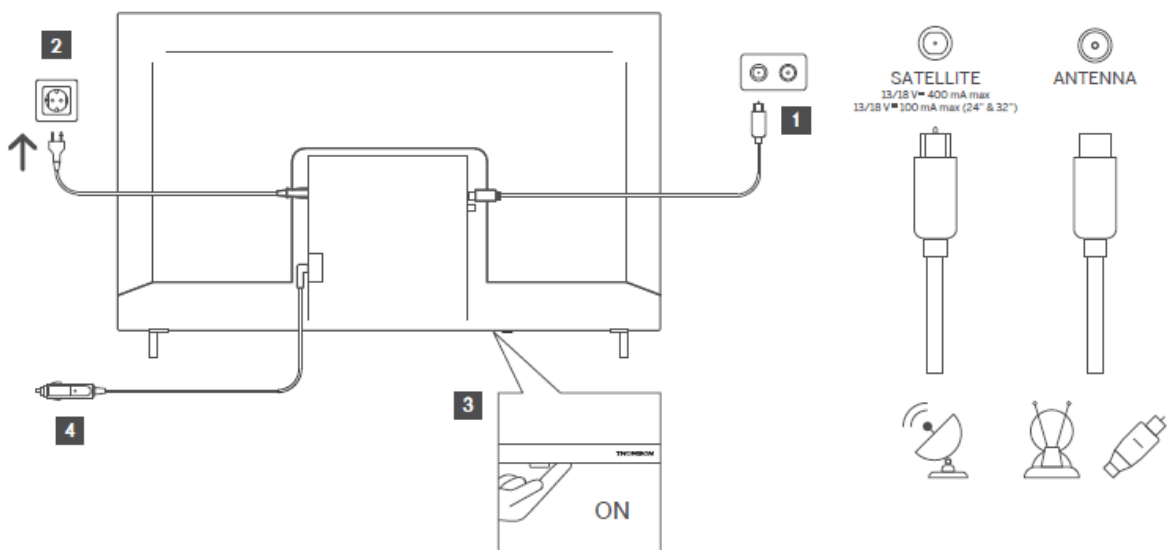

## 6 Initial setup

For the first initial setup, the on-screen setup wizard will guide you through setting up your TV. Please follow the instructions carefully to setup your TV correctly.

### 6.1 Pairing Bluetooth remote

Press the **BACK** and **Home** buttons simultaneously on your remote control to enter the Bluetooth pairing mode. The indicator light on the remote control will flash when starting the pairing process.

We recommend that you complete the remote-control pairing process. However, if you skip this, you can subsequently pair the remote control with the TV in the Settings > Remote controls & accessories menu.

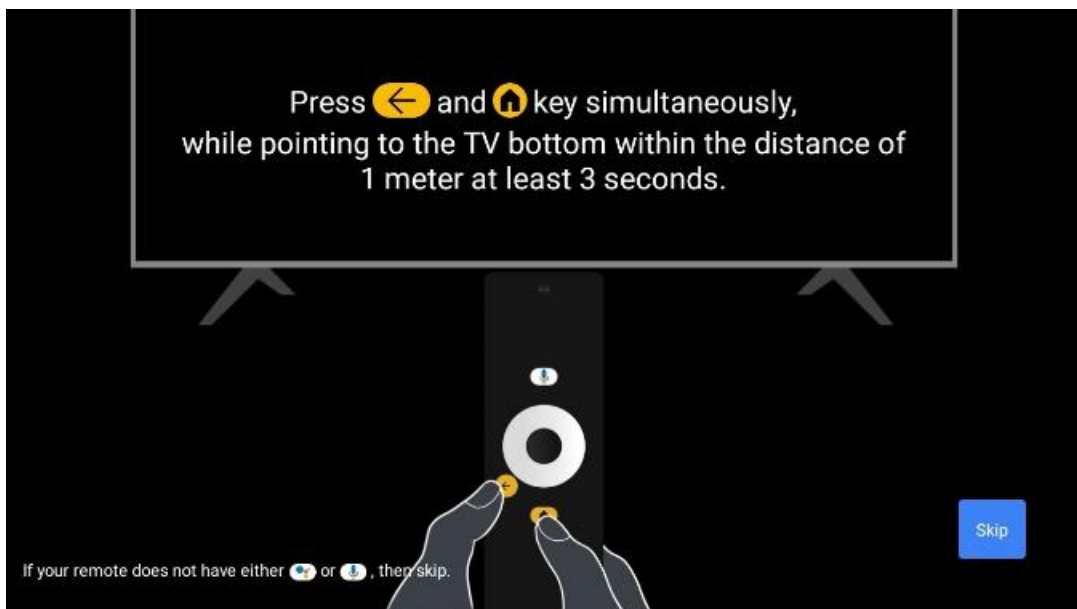

## 6.2 Language selection

Use up/down directional buttons to select system language, then press **OK** to confirm.

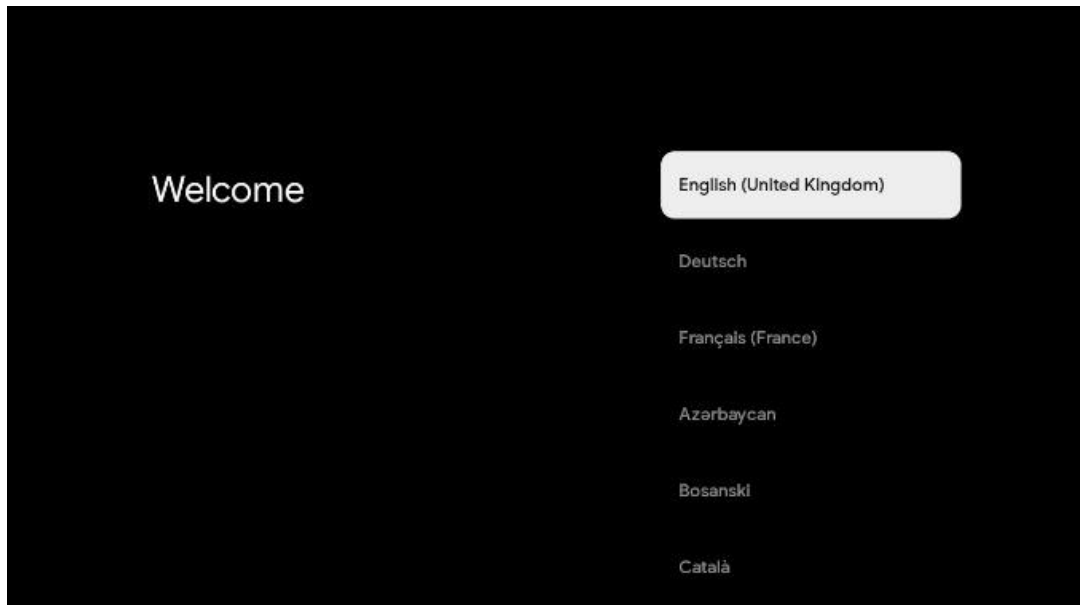

## 6.3. Region or country selection

Select the country you are located in to perform the installation correctly. This is important because the availability in the Google Play store and installation procedure of many applications depends on the geographic location (Geo-location). This is why certain applications are available for one country and not for others.

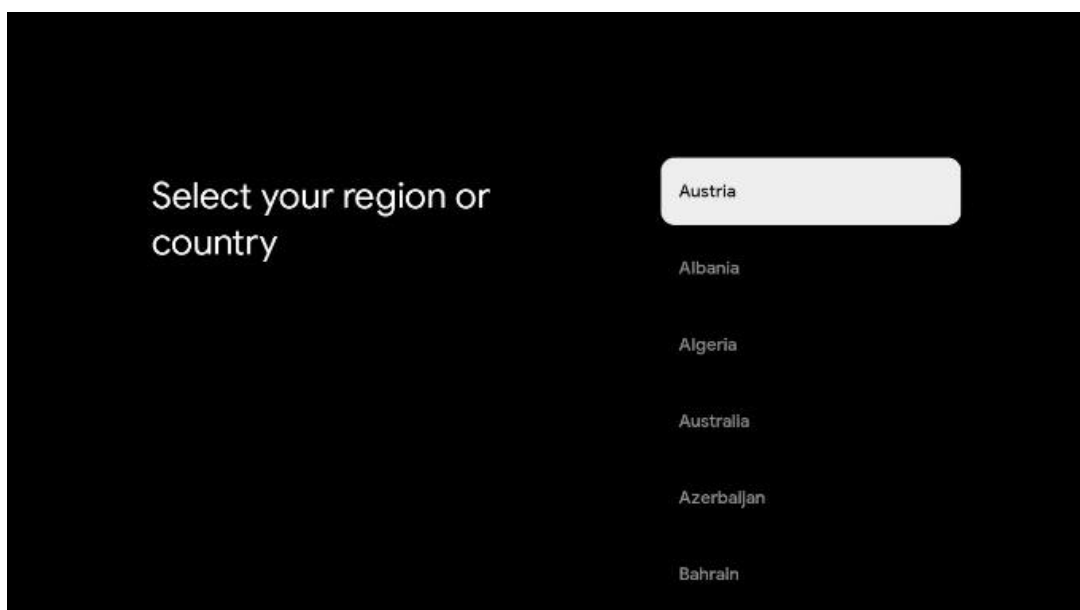

## 6.4 TV setup option

Use up/down directional buttons to select your TV setup option, then press **OK** to confirm.

**Note:** If you select Set up Google TV, you will require a Google account to proceed with the installation. You can use an existing Google account or create a new one.

**Note:** Please select the Set up basic TV option if you only want to use your TV to watch TV or listen to radio programs via terrestrial antenna, cable, or satellite antenna and if you do not want to connect your TV to the internet so that you can watch video contents from streaming Apps like YouTube or Netflix.

The detailed installation of the Basic TV option is described in the menu chapter 6.4.2.

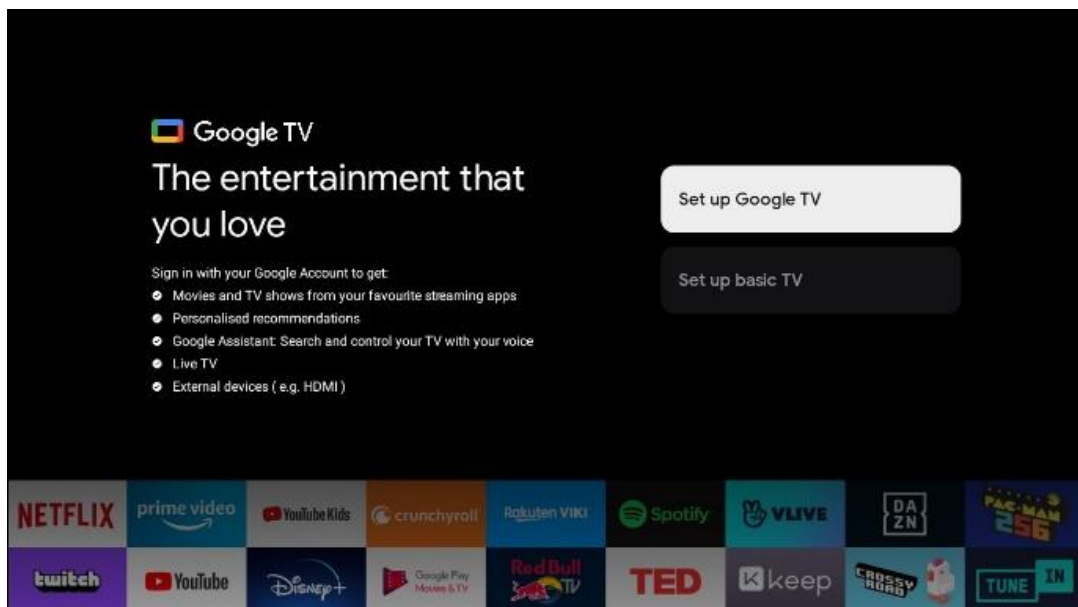



## 6.4.1 Set up Google TV

### 6.4.1.1 Set up with the Google Home app

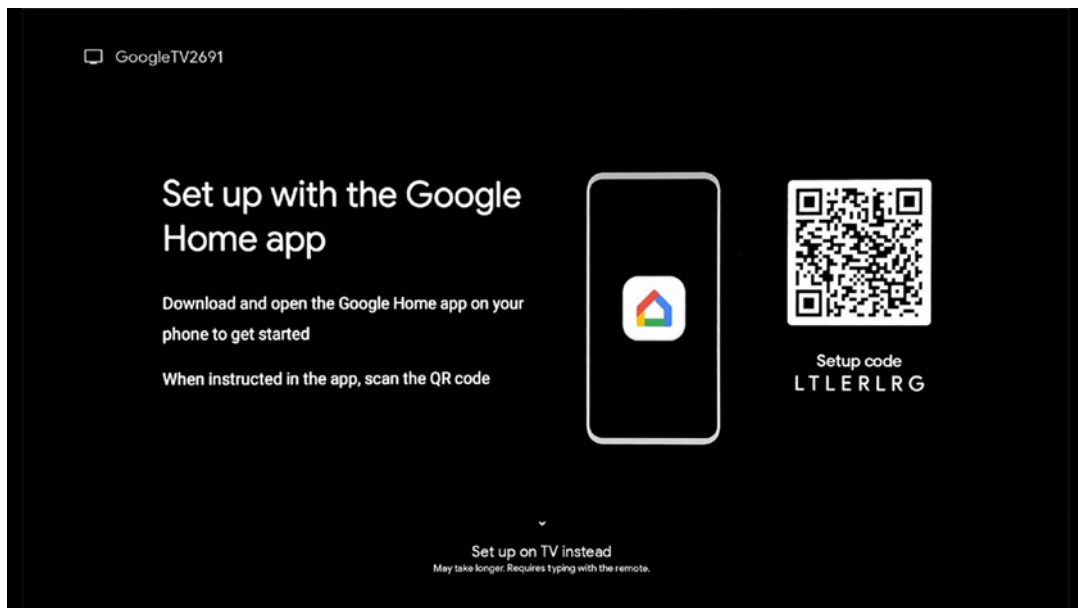

To set up with the Google Home app, it is necessary to have a mobile device (smartphone or tablet) with the Google Home app installed. To install the Google Home app, please scan the QR code on your TV or search for Google Home in the app store on your mobile device. If the Google Home app is already installed on your mobile device, open it and follow the instructions on your TV and mobile device. The setup of the TV via the Google Home application on your mobile device should not be interrupted.

**Note:** Some mobile devices with the latest Android OS version are not fully compatible with the installation of Google TV via Google Home App. Therefore, we recommend the installation option Set up on TV.

### 6.4.1.2 Set up on TV

To utilize the many advantages of your Google TV, your TV must be connected to the Internet. You can connect your TV to your modem/router wirelessly via Wi-Fi or by cable. Your internet connection will be automatically detected and displayed if you have connected your TV with the modem/router directly to the cable.

If you want to connect your TV to the internet wirelessly via Wi-Fi, press the up/down directional buttons to select the desired WLAN network, enter the password and then press Confirm to establish the connection. If you select Skip because you want to set up your TV as a Basic TV, you can configure the internet connection later in the TV Settings menu.

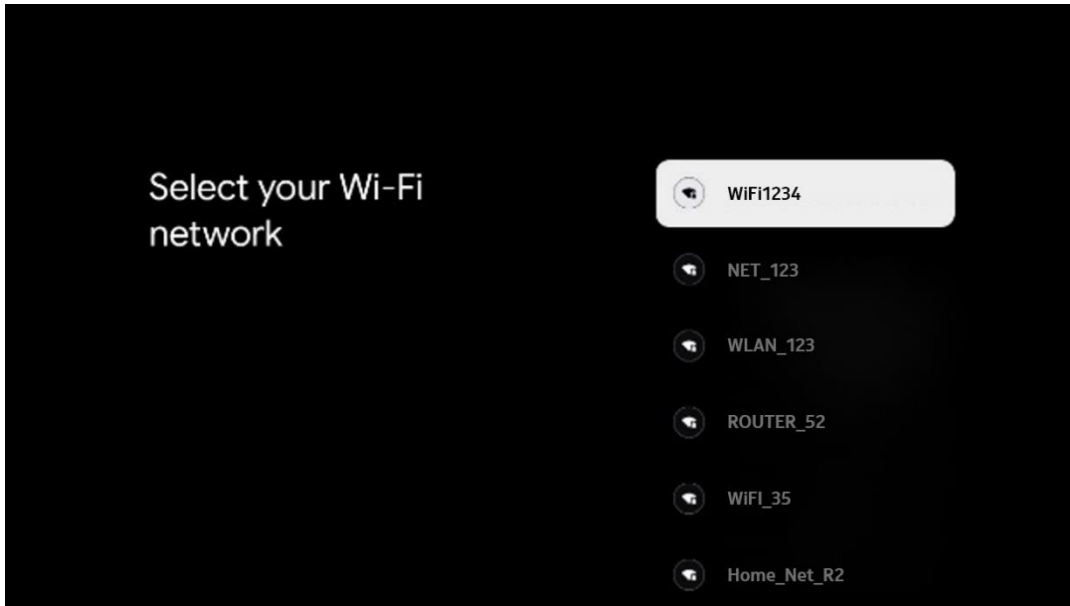

#### 6.4.1.3 Sign-in with your Google account

To sign in with your Google account, enter your email address and your password.

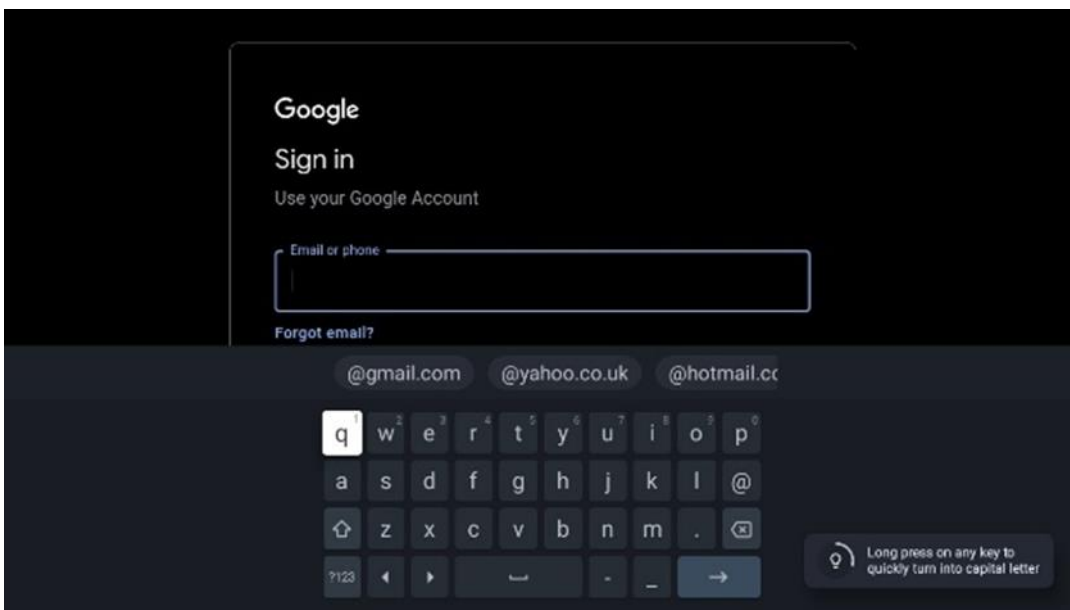

#### 6.4.1.4 Google Terms of Services

Before you continue, please take the time to read the General Terms and Conditions, the Terms of Use for Games, the Privacy Policy, and the available Google services. You declare your agreement with these services by clicking on Accept.

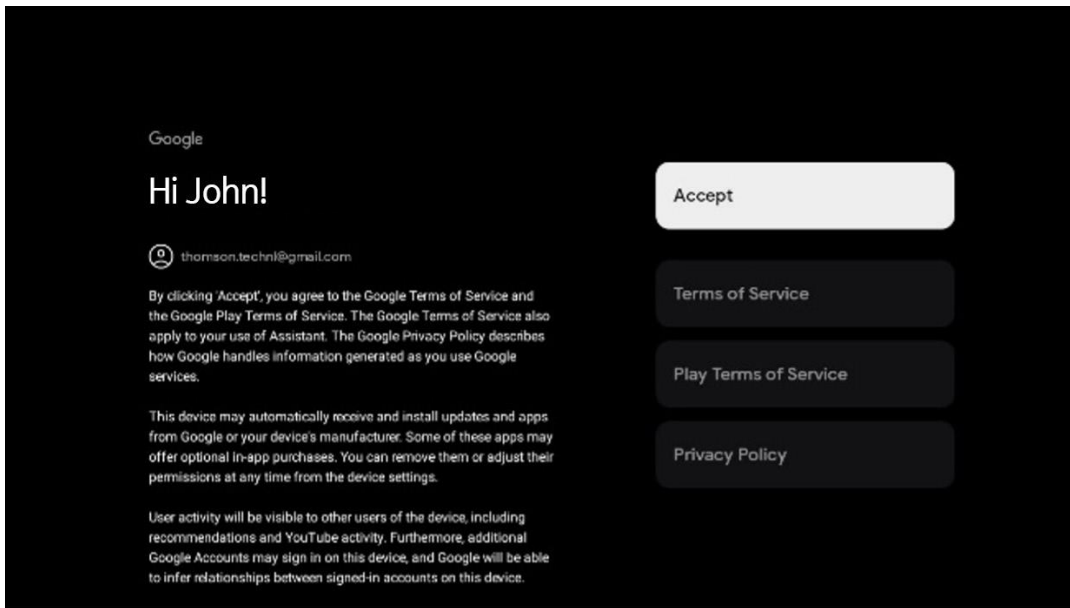

Select Accept to confirm if you want your location identified on your Google Privacy Policy and agree to automatically send diagnostic information to Google to help improve your Google experience.

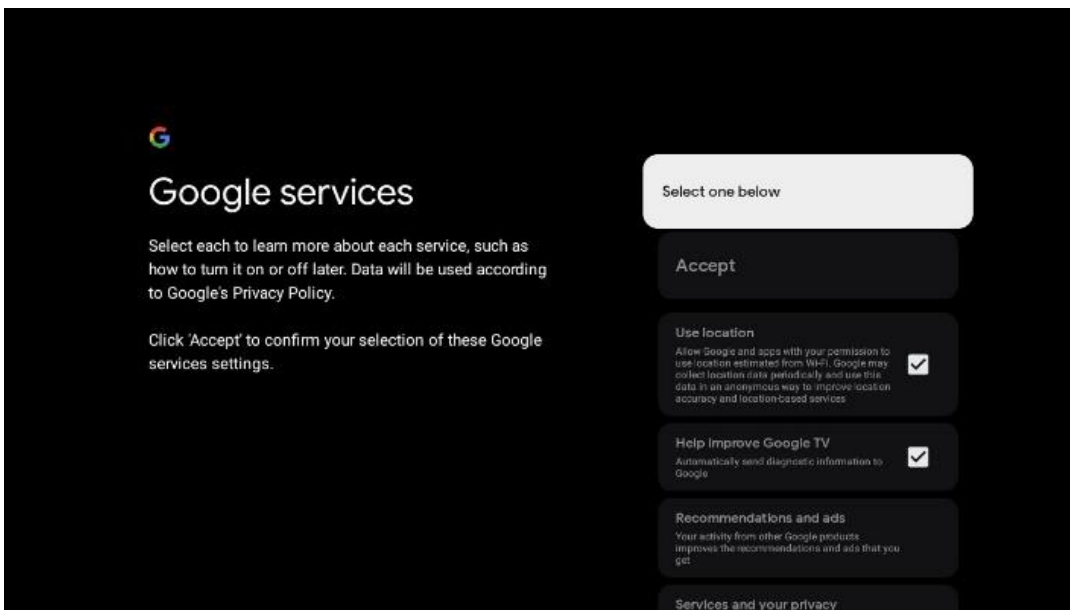

#### 6.4.1.5 Confirm or reject Google services and features

Carefully read through the services and functions that your TV offers. If you don't want to activate one or more of the offered services, you can reject them by clicking No, thanks.

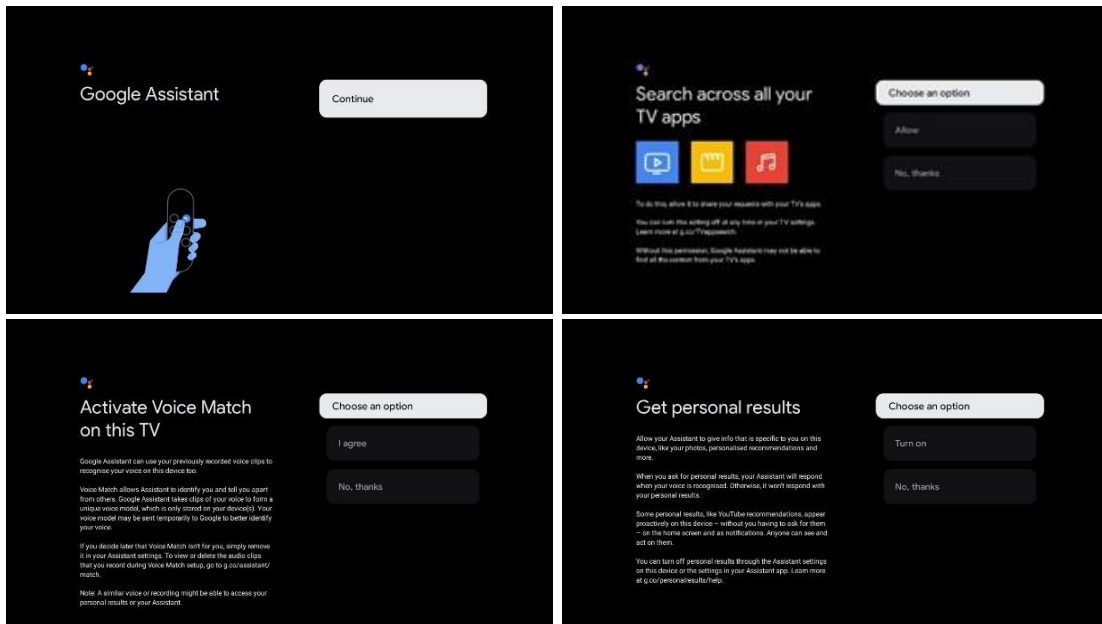

### 6.4.1.6 Choose your subscriptions

In this step you can select which streaming applications you would like to install automatically. These might be applications for which you already have a subscription for, or applications suggested to you by Google.

Some applications are already pre-selected. You can deselect them, which means that they won't be automatically installed during the first set-up process.

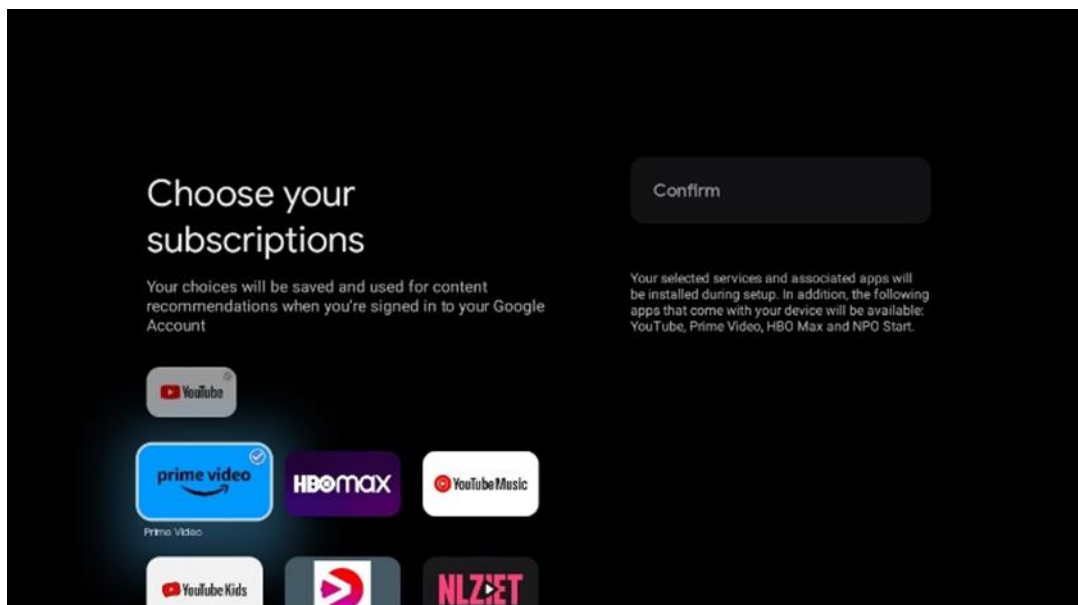

### 6.4.1.7 Set up password

Press the **OK** button to input your 4-digit password and follow the steps on the screen. First you will need to choose a new password, then you need to confirm it again. You will need this password to edit functions, like parental controls or to reset your TV to the factory settings.

# Password

Please set password. '0000' is invalid.

# Input password

New password

1	2	3	✕
4	5	6	0
7	8	9	✓

# Confirm password

Confirm password

1	2	3	✕
4	5	6	0
7	8	9	✓

#### 6.4.1.8 Select TV mode (Home / Shop)

During the installation set-up, you have the option to customize your viewing experience by choosing your preferred TV mode. If you choose Home mode, your TV will function as usual, providing entertainment in your home environment.

Alternatively, selecting Shop mode will configure your TV to display pertinent information directly on the screen. This feature is commonly utilized in retail settings to showcase key details about the TV to potential customers.

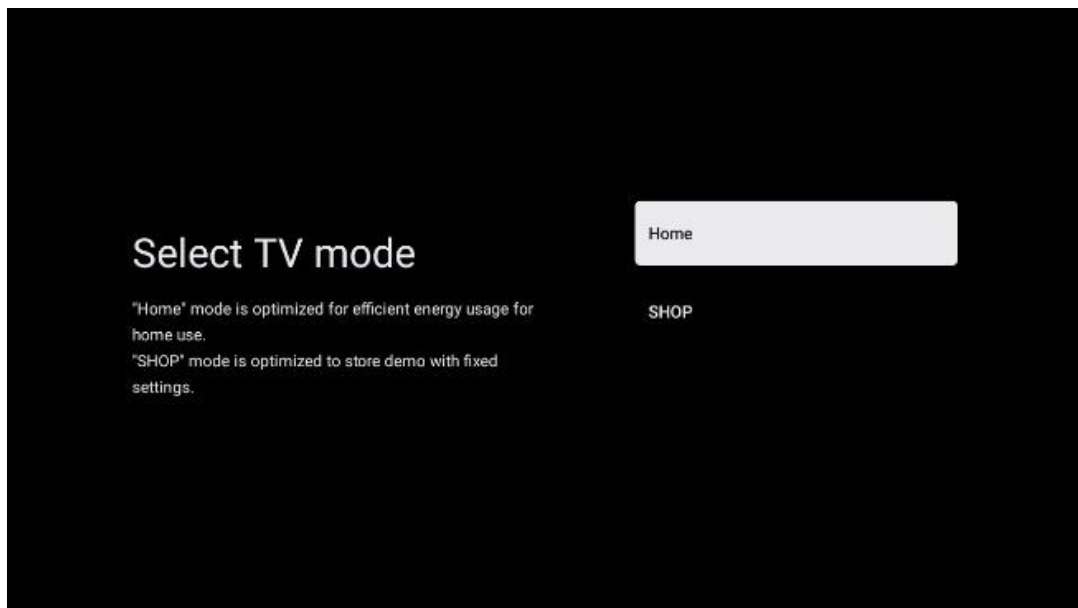

#### 6.4.1.9 Chromecast built-in

Activating the Chromecast function enables you to stream content from streaming applications directly to your TV, or to play digital multimedia content stored on your mobile devices, such as smartphones or tablets, on your TV screen.

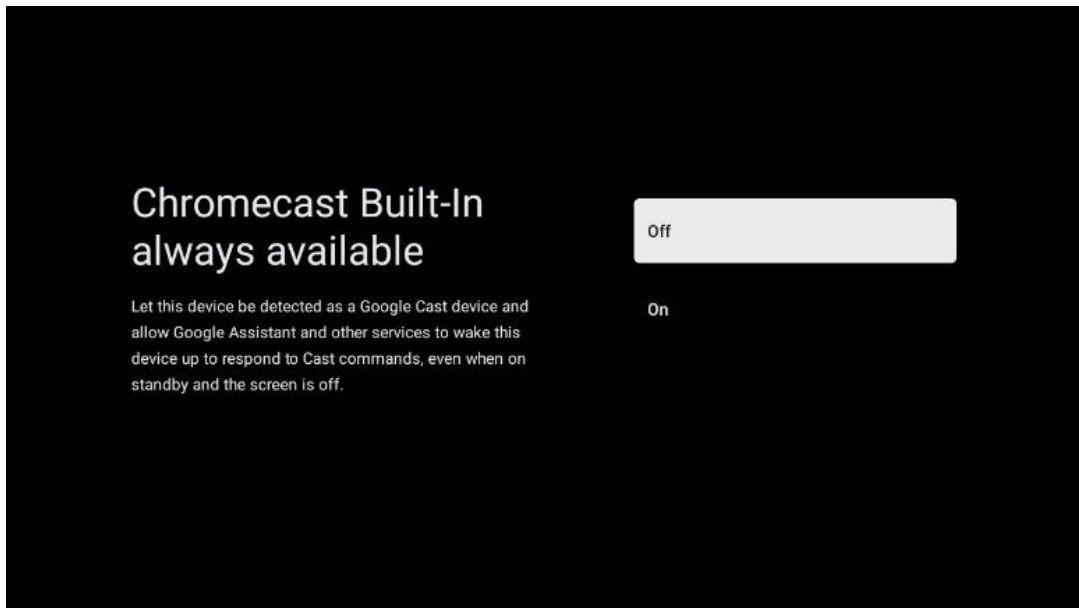

#### 6.4.1.10 Tuner mode

The installation of the TV signal receiver tuner is described in detail in menu chapter 7.

### 6.4.2 Set up basic TV

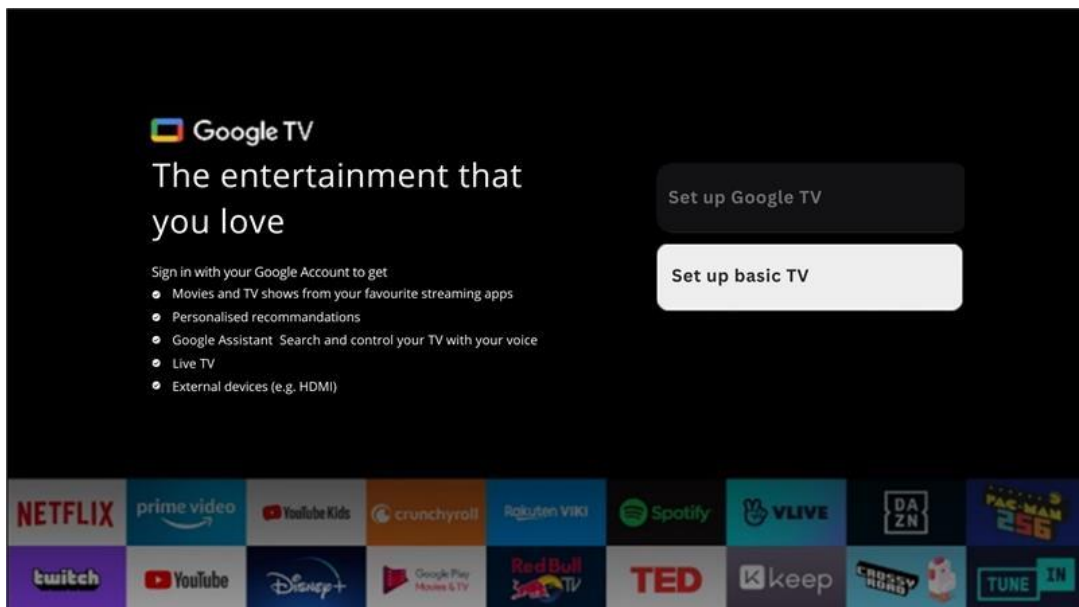

Please select the installation option Set up basic TV if you only want to use your TV to watch TV or listen to radio programs via terrestrial antenna, cable, or satellite antenna and if you do not want to connect your TV to the internet so that you can watch video contents from streaming Apps like YouTube or Netflix.

### 6.4.2.1 Select your Wi-Fi network

If you do not want to watch content from streaming services like Netflix or YouTube, select the Skip option at the end of the list of available Wi-Fi networks.

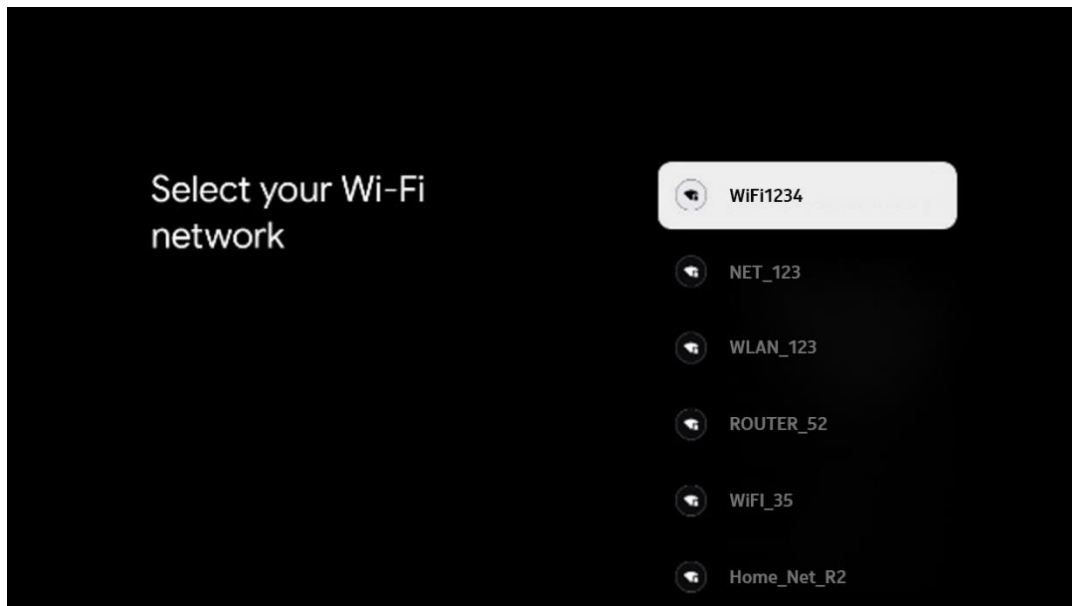

### 6.4.2.2 Google Terms of Services

Before you continue, please take the time to read the General Terms and Conditions, the Terms of Use for Games, the Privacy Policy, and the available Google services. You declare your agreement with these services by clicking on Accept.

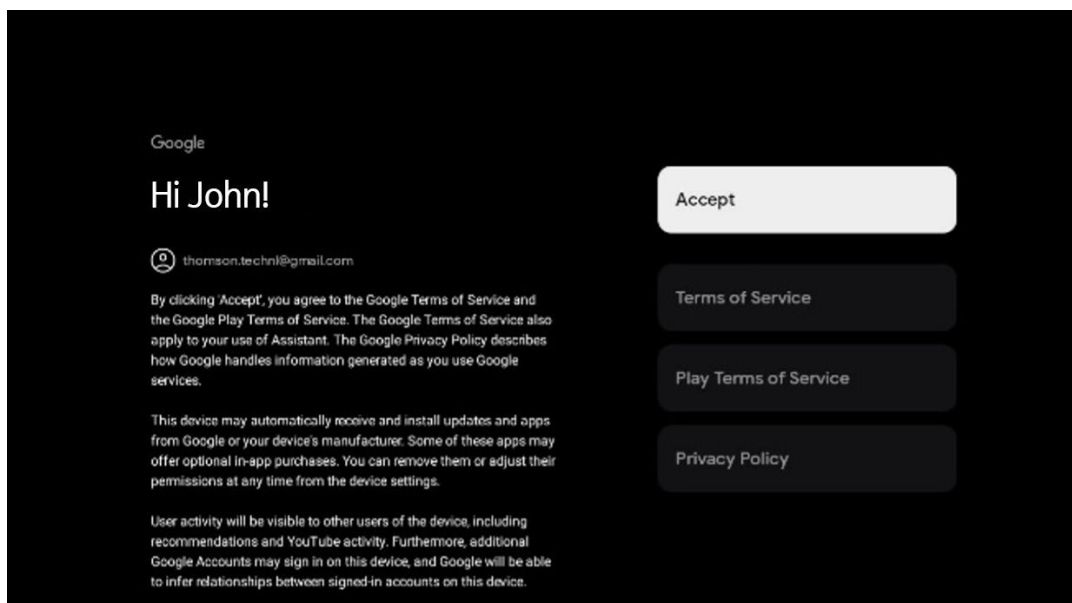

### 6.4.2.3 Set up password

Press the **OK** button to input your 4-digit password and follow the steps on the screen. First you will need to choose a new password, then you need to confirm it again. You will need this password to edit functions, like parental controls or to reset your TV to the factory settings.



# Password

Please set password. '0000' is invalid.

Input password

# Input password

New password

1	2	3	⌫
4	5	6	0
7	8	9	✓

# Confirm password

Confirm password

1	2	3	⌫
4	5	6	0
7	8	9	✓

### 6.4.2.4 Select TV mode

During the installation set-up, you have the option to customize your viewing experience by choosing your preferred TV mode. If you choose Home mode, your TV will function as usual, providing entertainment in your home environment.

Alternatively, selecting Shop mode will configure your TV to display pertinent information directly on the screen. This feature is commonly utilized in retail settings to showcase key details about the TV to potential customers.



### 6.4.2.5 Chromecast built-in

Activating the Chromecast function enables you to stream content from streaming applications directly to your TV, or to play digital multimedia content stored on your mobile devices, such as smartphones or tablets, on your TV screen.

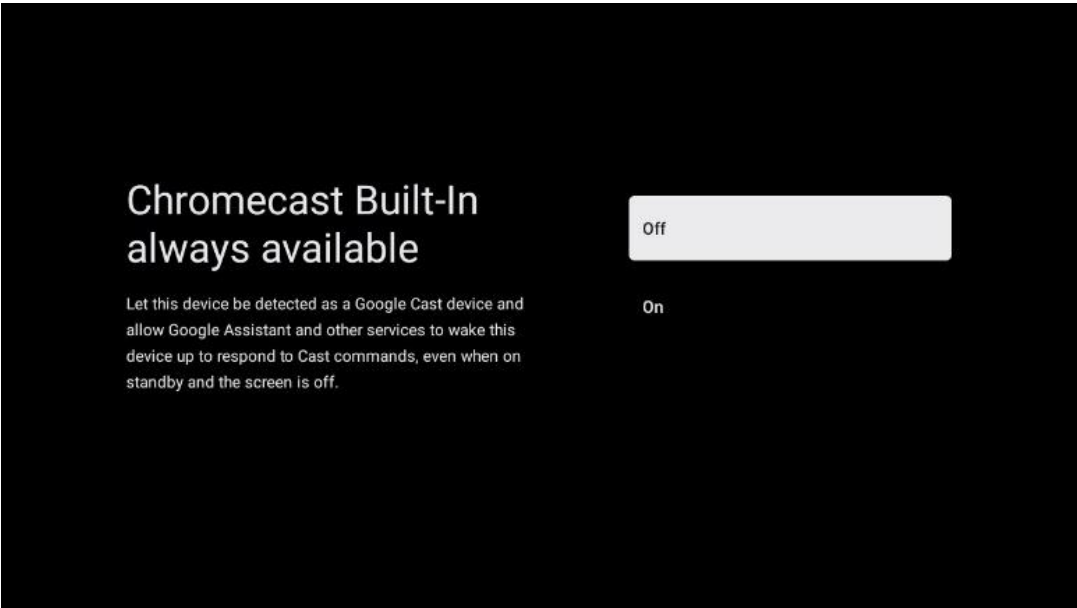

### 6.4.2.6 Tuner mode

The installation of the TV signal receiver tuner is described in detail in menu chapter 7.

## 7 Tuner mode

Select your TV reception type Tuner to install TV/Radio channels. The reception type options Terrestrial Aerial, Cable and Satellite are available. Highlight the available TV signal reception type option and press **OK** or click on the right directional button to continue.

If you select Skip scan, you can finish the first installation process of the TV without installing the TV channels. You can subsequently install the TV channels in the TV Settings Menu.

### 7.1 Aerial

If the Antenna option is selected, the TV will search for digital terrestrial and analogue broadcasts. On the next screen highlight the Scan option and press **OK** to start the search or select Skip Scan to continue without performing a search.

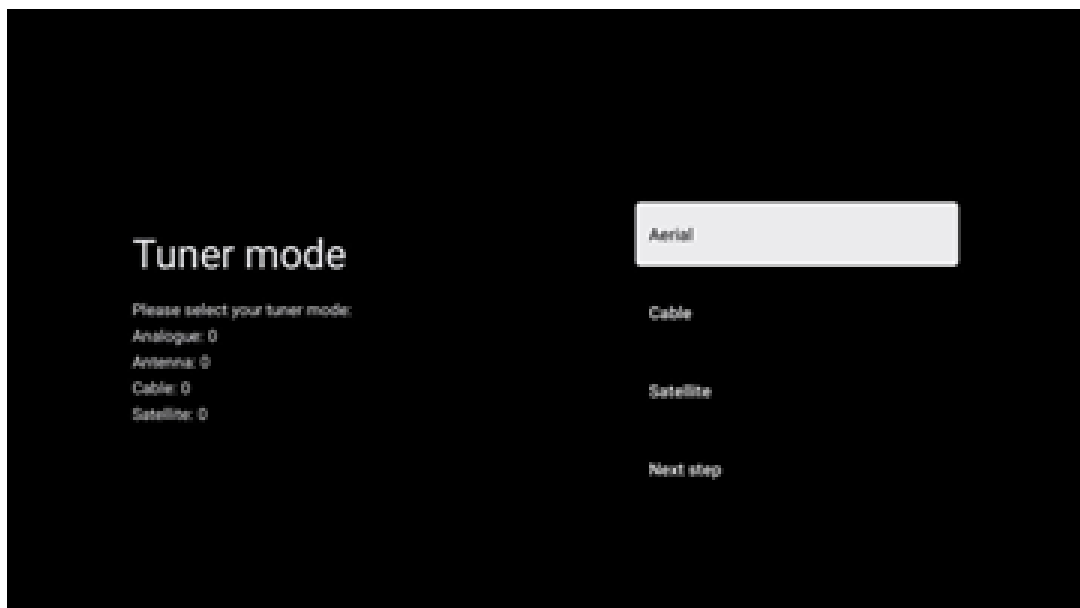

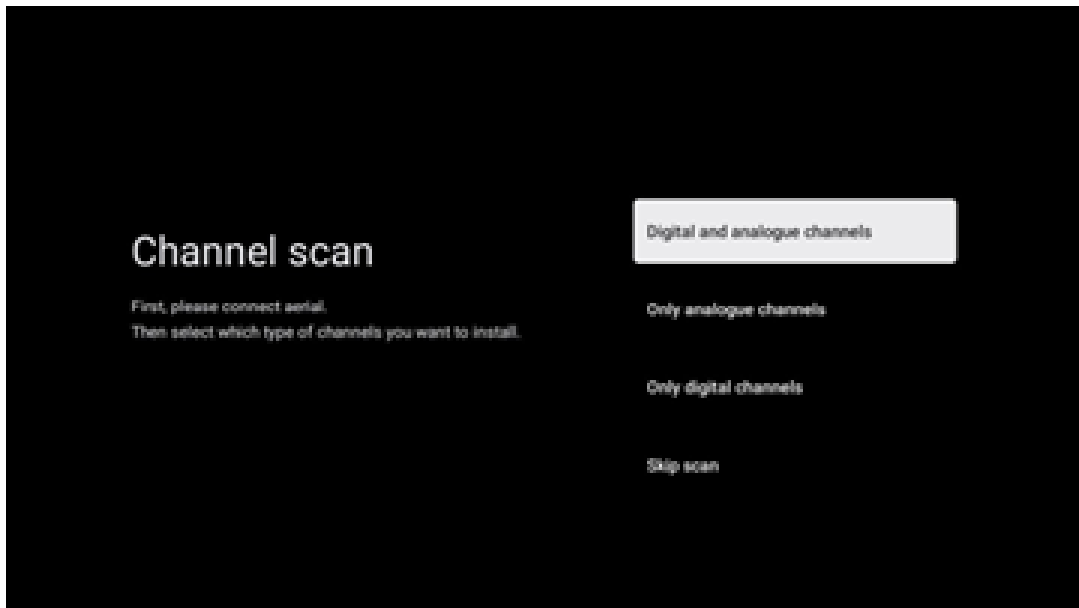

## 7.2 Cable

If the Cable option is selected, the TV will search for digital cable channels.

In most cable channel networks, only digital channels are available. Select Digital to continue the scan.

**Operator Scan:** If available, the cable operators will be listed on the screen. Highlight the desired operator and press **OK**. Select Start and press **OK** to perform the channel scan.

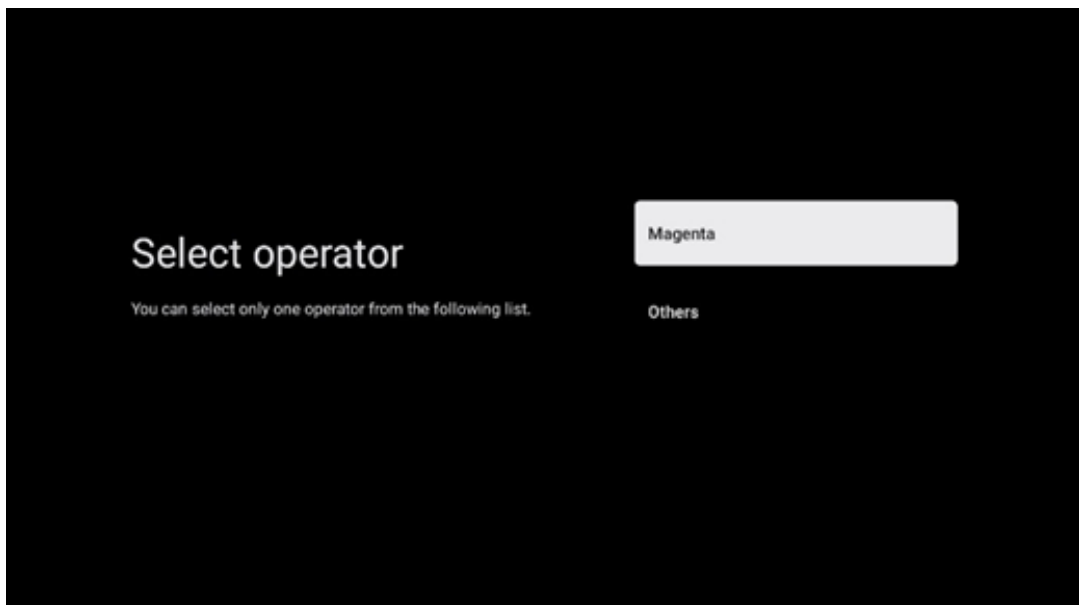

**Others:** Select the option Others if your cable operator is not listed or if your TV is connected to a local cable system. Select Scan Type and press **OK** to display the scan options.

**Full scan:** An automatic full search searches the entire frequency band; this should be selected if not all channels were found during a network search.

**Quick scan:** A quick search will be started, which will bring the channels into a pre-sorted order. With this type of search, it is necessary to enter the network ID and center frequency.

**Network scan:** With a network search, a complete and up-to-date channel list of a provider is transmitted, so the receiver recognizes all channels, which is preferable for cable TV operators. With this type of search, it is necessary to enter at least the network ID.

Select **Skip Scan** to continue without performing a search.

## 7.3 Satellite

### **Note for the installation of satellite channels for Thomson TVs installed in Austria or Germany:**

Our Thomson TVs have the Load Channel List function, which can only be selected and executed during the initial installation of the TVs. This function is **only** available if Austria or Germany were selected as installation countries during the initial installation of the TV.

This function will **only** be performed during the initial installation of the TV when you install the satellite channels.

To activate it, follow the installation steps below:

1. Tuner mode menu - select Satellite as the installation option.
2. Antenna type menu -select Next if you can receive only satellite channels from **Astra 19,2° East** satellite or select the More submenu if your TV is connected to a satellite receiving antenna for multiple satellite reception. In this Menu, you can select the correct control type for your satellite system.
3. Press the **OK** button to confirm your selection.
4. Select the General installation option and confirm your selection with the **OK** button.
5. Menu Load Preset List - Select the menu option Load Preset List to load the channels or select the option Skip to continue without installing the TV and radio channels.

As mentioned above, the Load Channel List installation option is only available during the initial installation of the TV. If you then wish to perform the General search option while the TV is in operation, the TV will perform a transponder search, scanning the available satellite transponders for frequencies and storing the satellite TV and radio channels one by one.

## 7.3.1 Antenna type

### 7.3.1.1 Next

Select Next if your TV is connected to the satellite system with reception of only one satellite.

If Satellite option Next is selected, General Satellite and Operator scan options will be available. Select an installation option and press **OK** or click on the right directional button to continue.

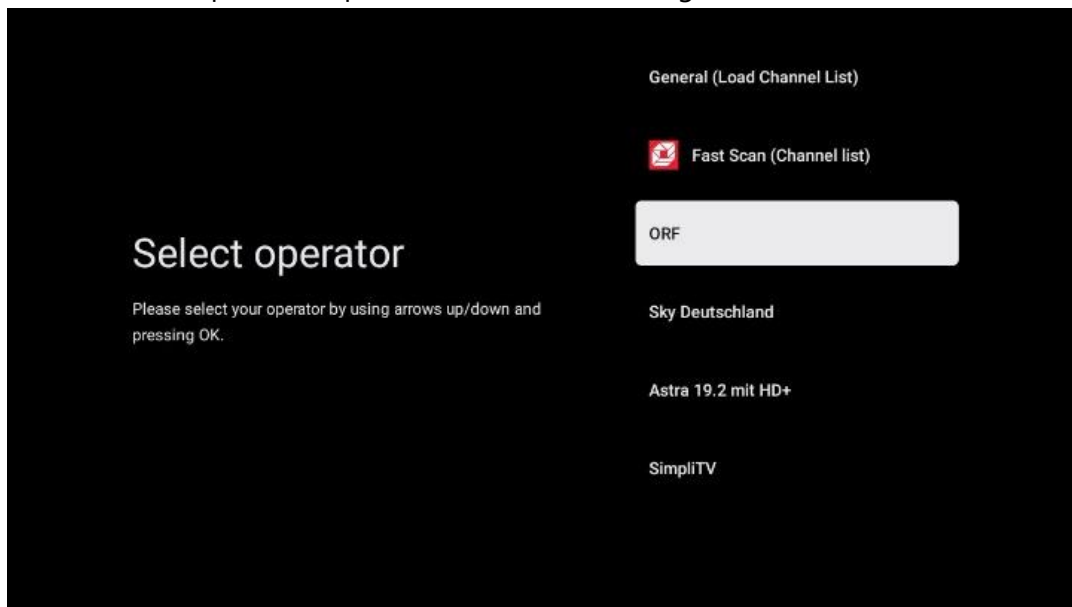

**Note:** General Satellite and Operator list options may not be available depending on the selected country.

#### **Operator scan:**

Highlight the desired operator and press **OK** to confirm your selection. Then press the right directional button to continue with the Operator scan.

You can only select one operator from the list. The TV/radio channels found are sorted according to the LCN order of the selected operator.

#### **General scan:**

With the General search option, the selected satellites are searched from the lowest to the highest satellite transponder frequency and the stored TV/radio channels will be listed one after the other according to the search progress in no particular order.

### 7.3.1.2 More

Select More if your TV is connected to a satellite system for reception of multiple satellites or to a 1-cable satellite system.

You will see the following screen with some available connection options. Select one of these options which is correct for your home satellite installation network. You may be able to set up different satellites depending on the selected antenna type.

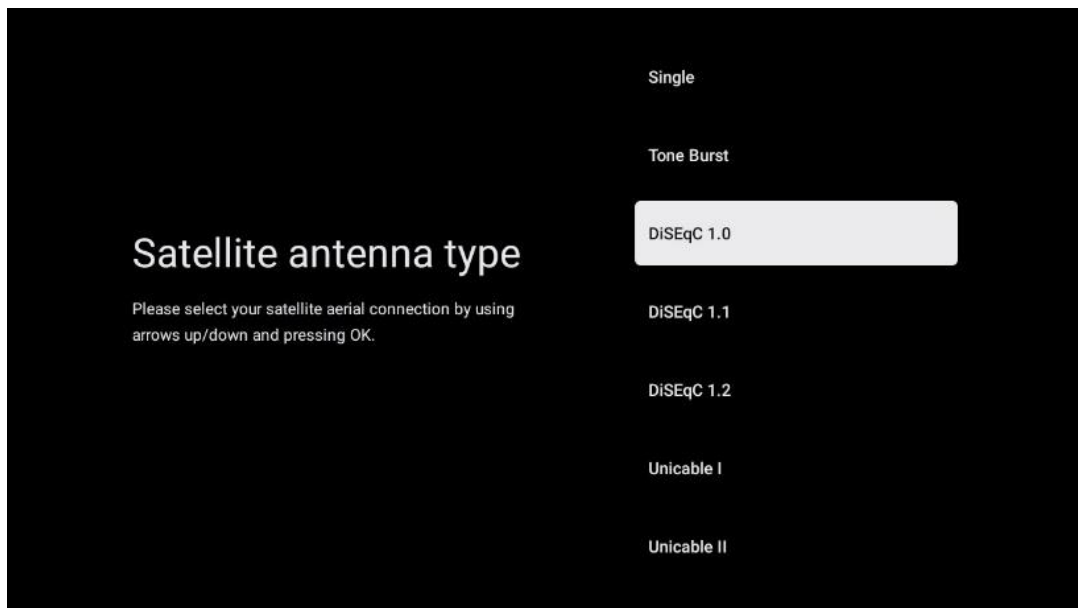

Following Satellite antenna connection types are available:

- **Single**- Satellite system with reception of only one Satellite.
- **Tone burst** – Satellite system with reception of two Satellites.
- **DiSEqC 1.0**- Satellite system with reception of 1-4 Satellites.
- **DiSEqC 1.1**-Extension of the DiSEqC 1.0 protocol and allows the control of multi-feed systems with up to 64 LNBs (Satellites) via the antenna cable.
- **DiSEqC 1.2** -is used to control a motor for rotary systems. The motor can save various positions, which are then approached automatically via DiSEqC 1.2.
- **Unicable I** - Unicable I is a method for distributing satellite TV signals in a satellite system. Several receivers can be connected to a single line. With Unicable I, up to 8 users can be connected to one antenna cable. More about the Unicable distribution system is described in the Channel Menu.
- **Unicable II** - This Unicable II satellite signal distribution system, also called Jess Unicable, is based on Unicable I digital channel stacking technology and enables installations with up to 32 satellite receivers connected over a single coax cable.

## 8 Home screen

The Home screen is the centerpiece of your TV. From the Home screen, you can launch any installed Application, launch the Live TV application to watch TV broadcasts, watch a movie from various streaming applications or switch to a device connected to the HDMI port. You can also exit the operation of any application at any time and return to the Home screen by pressing the Home button on the remote control.

In the first (Top picks for you) row, the streaming content of the streaming applications installed on your TV will be suggested according to your search criteria in your search history. Here you will also find the direct selection of the last TV input connection selected. In this line, on the first position, you will also find the selection box with the last Input source, if the HDMI CEC control function is enabled on this device.

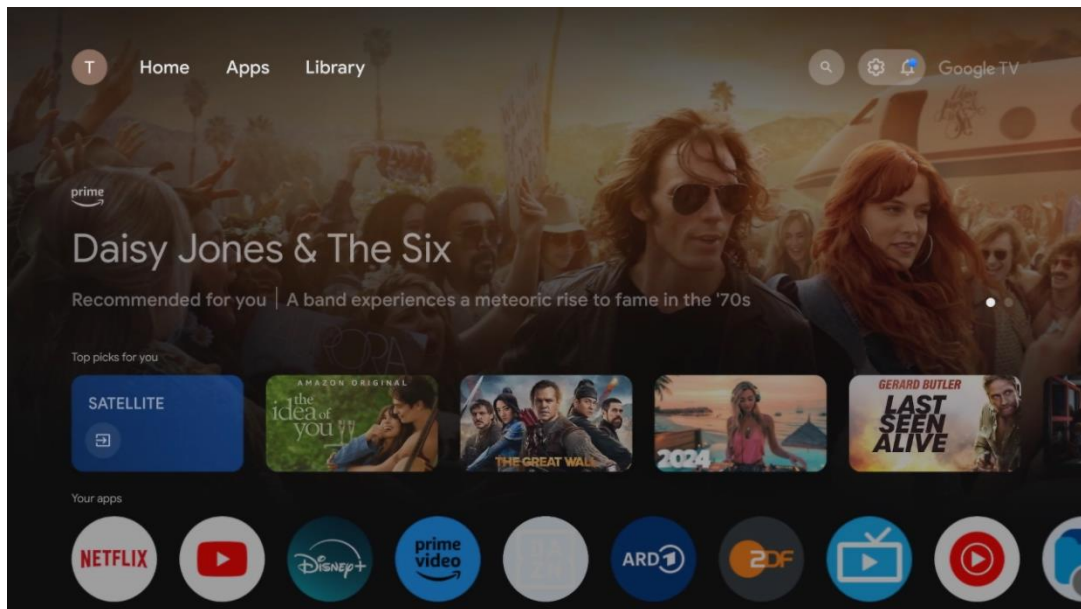

**Note:** Depending on the settings of your TV set and your country selection during the initial setup, the Home menu may contain different elements.

The second (Your apps) row is the row of applications. The most important applications for streaming services such as Netflix or YouTube as well as live TV and MMP (multimedia player) can be found here.

Select an application with the directional buttons on your remote control and confirm your selection with the **OK** button to start the selected application.

Select an application and press and hold the **OK** button to remove the selected application from the row of favorites, move it to a new position or launch it.



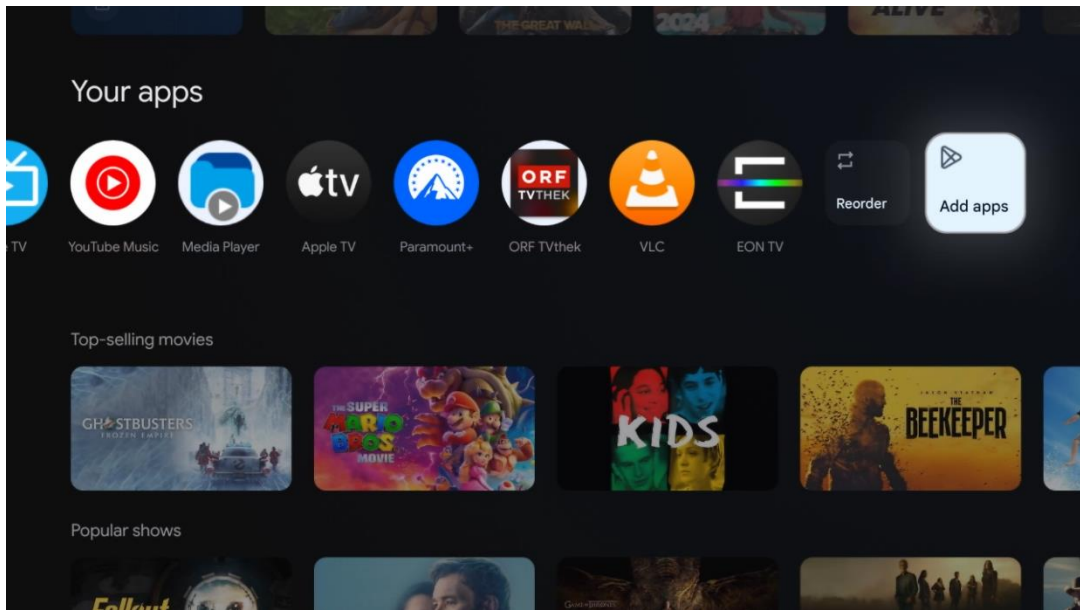

On the penultimate and last position in this row you will find boxes with the options Reorder and Add apps. Select these options to reorder the applications in this row or to add new application to this Favorite applications row.

The operation of the live TV application and the multimedia player is explained in a separate Menu chapter.

Further down on the home screen, you will find additional channels displayed by genre or streaming content category.

## 8.1 Google Account

Navigate to your profile icon at the top left corner and press **OK**. Highlight the profile icon and press **OK**.

Here you can change your profile settings, add new Google accounts, or manage already existing accounts.

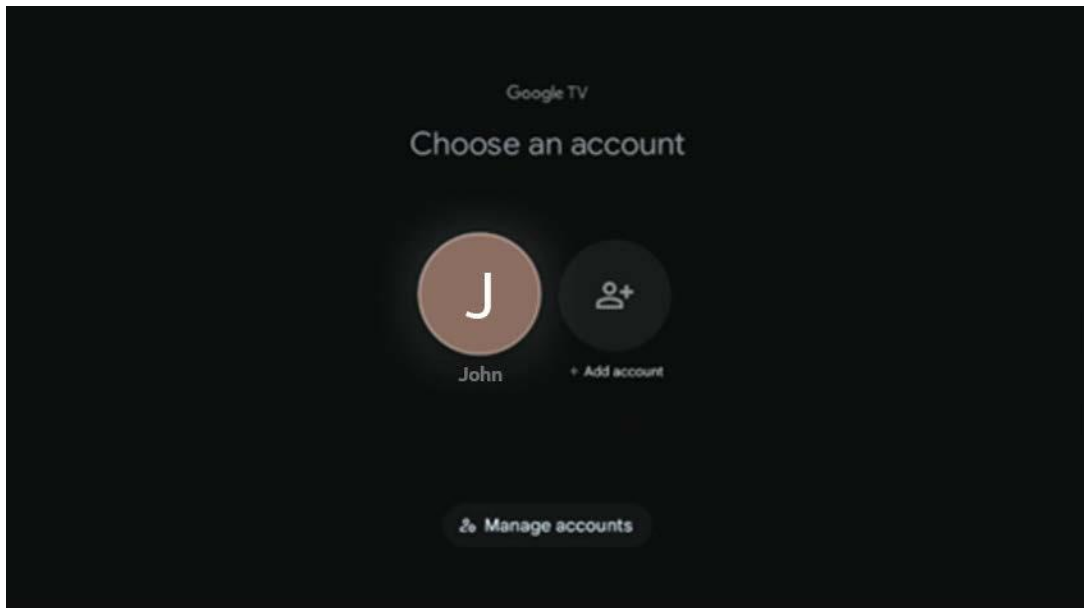

## 8.2 Apps

Select the Apps tab on the Home screen to display applications installed on your TV. To install an application, go to the search bar and type in the name of the app. This will start a search in the Google Play Store.

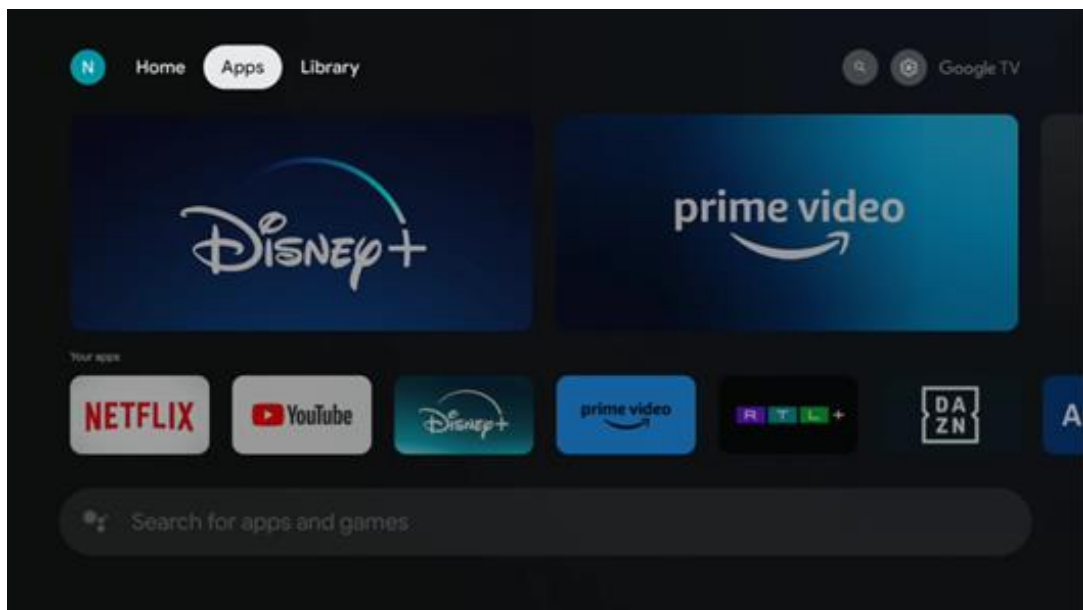

## 8.3 Library

Select the Library tab on the home page to play the streaming content you have already purchased or rented on your TV or mobile devices such as your mobile phone or tablet using your Google account.

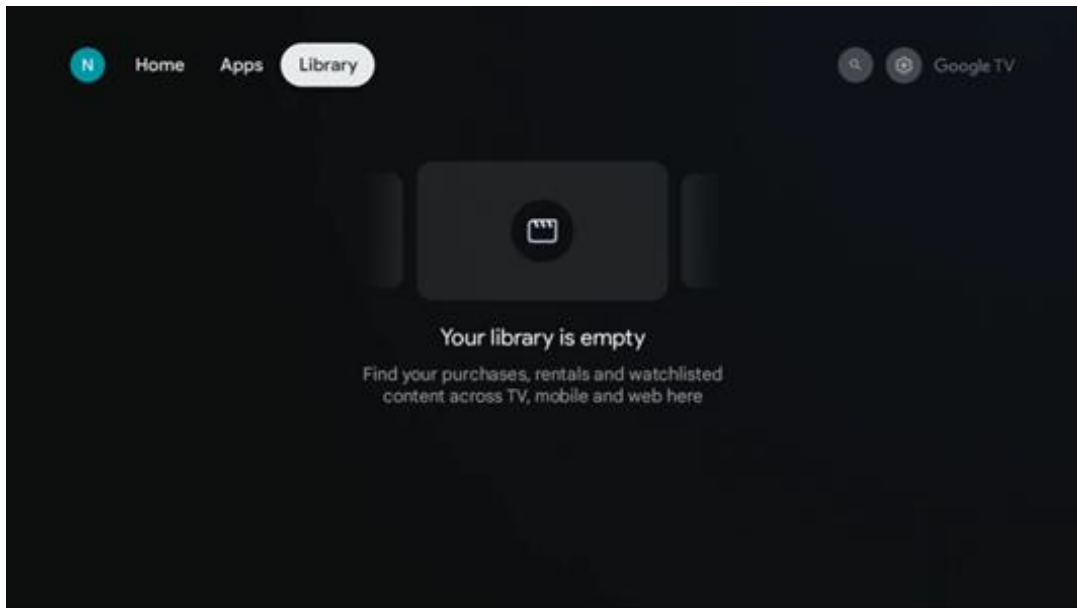

## 8.4 Google TV search

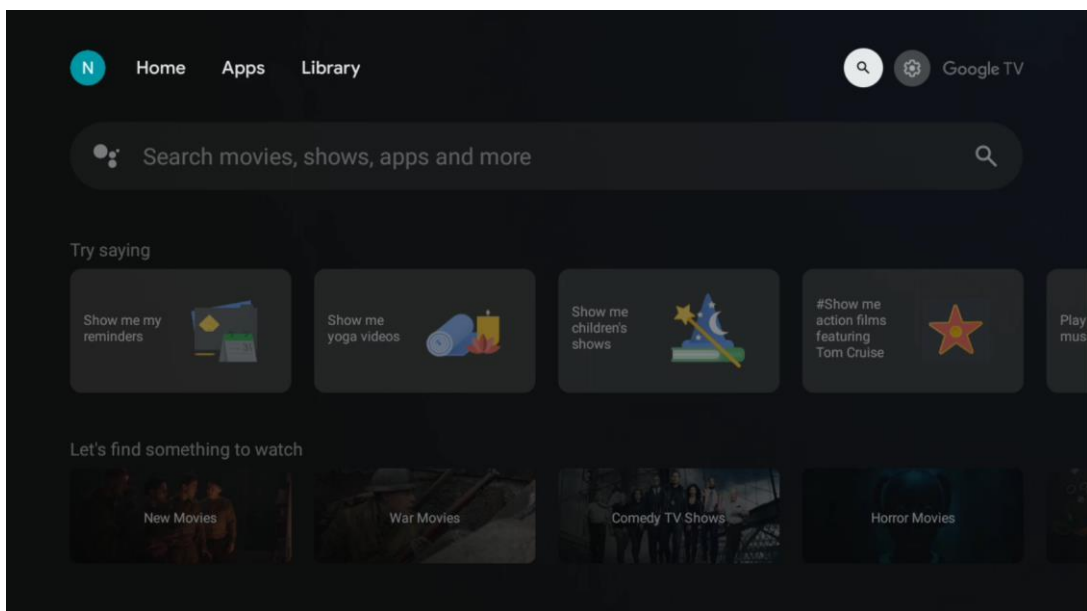

The search tools are located at the top right of the screen. You can either enter a word to start a search using the virtual keyboard or try voice search using the microphone built into your remote control. Move the focus to the desired option and press **OK** to continue.

Voice search – Press the microphone icon to start the voice search function. A Google voice search field appears at the top of the screen. Ask your question to Google and your TV will answer you. For local search terms it is important that the Menu language of the TV is set to the local language.

Keyboard search – Select the search bar and press **OK**. The virtual Google keyboard will appear on the screen. Type the question you want answered.

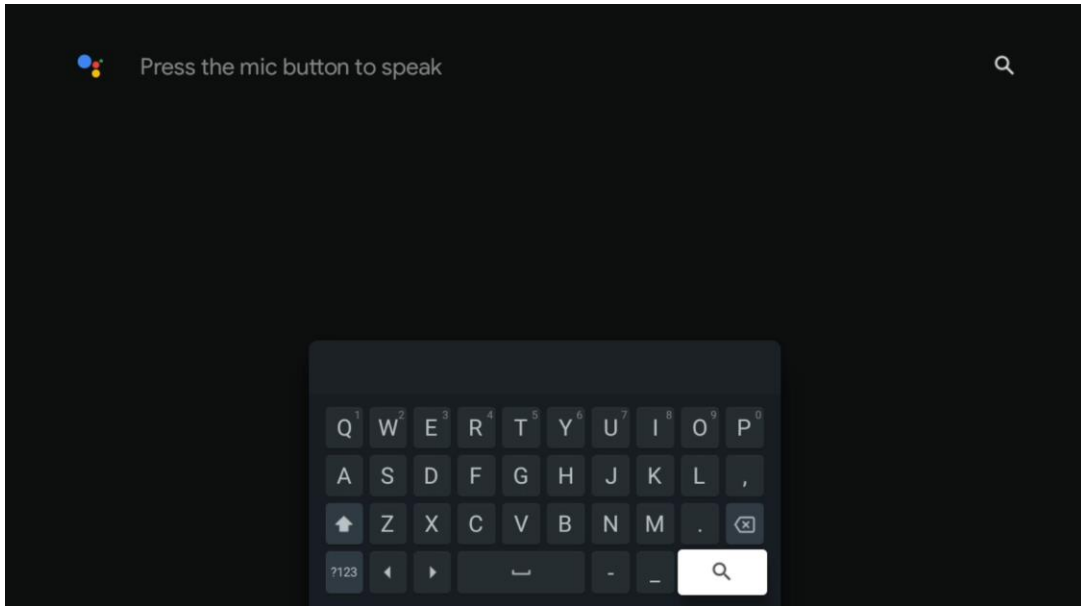

## 8.5 Notifications

The notification button appears only when there is one or more unread notifications. To check them, please, navigate to the Settings icon, which will open the submenu. At the bottom of the submenu, you will be able to find all the latest notifications.

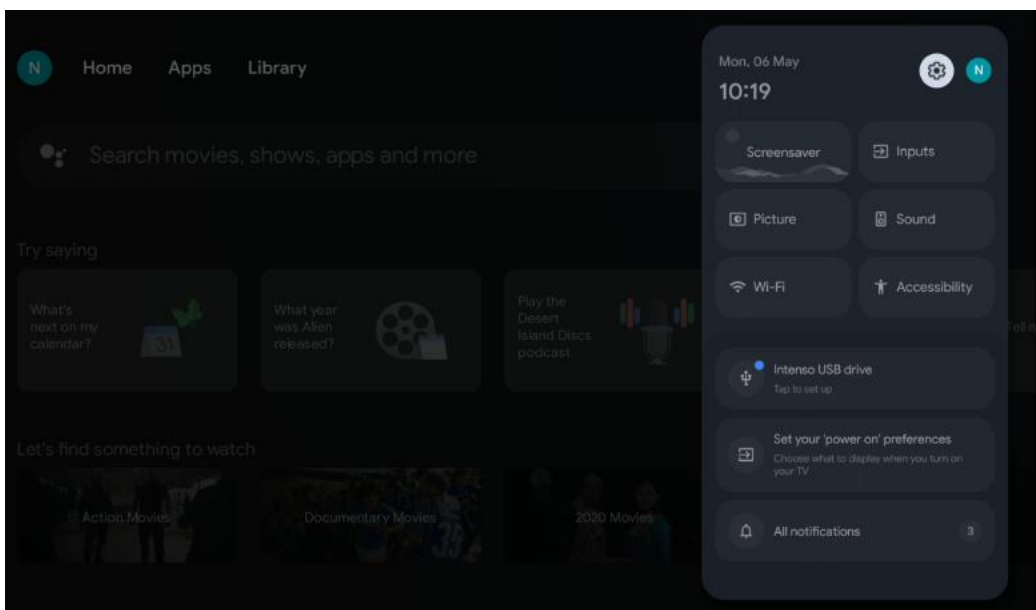

## 9 Settings

To see the full list of available settings, navigate to the Home Screen, by pressing the Home Screen button. Click on the Settings button in the right top corner.

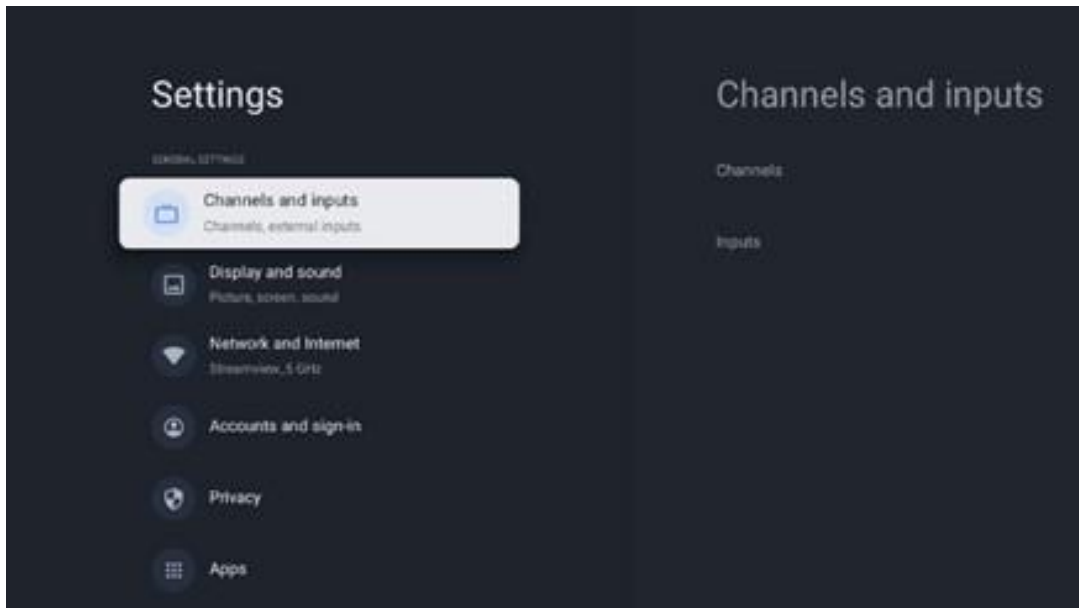

\* The above pictures are for reference only, please refer to the product for details.

**Note:** If you click the **Settings** button during the operation of media streaming applications, like YouTube, Netflix, Prime Video etc., you might enter the Display and Sound menu instead. There you can tune Picture, Screen, Sound and Audio output settings without exiting the operation of media streaming applications.

## 9.1 Set your device name

In this menu you have the option to select the name of your TV from the list of suggested names. You can also assign a customized name for your TV.

This is important for operating the Chromecast function so your TV will be identified with the correct name. By assigning the TV name, your TV will also be correctly identified in your home network.

## 9.2 Channels and inputs

Scan for available channels and available Inputs.

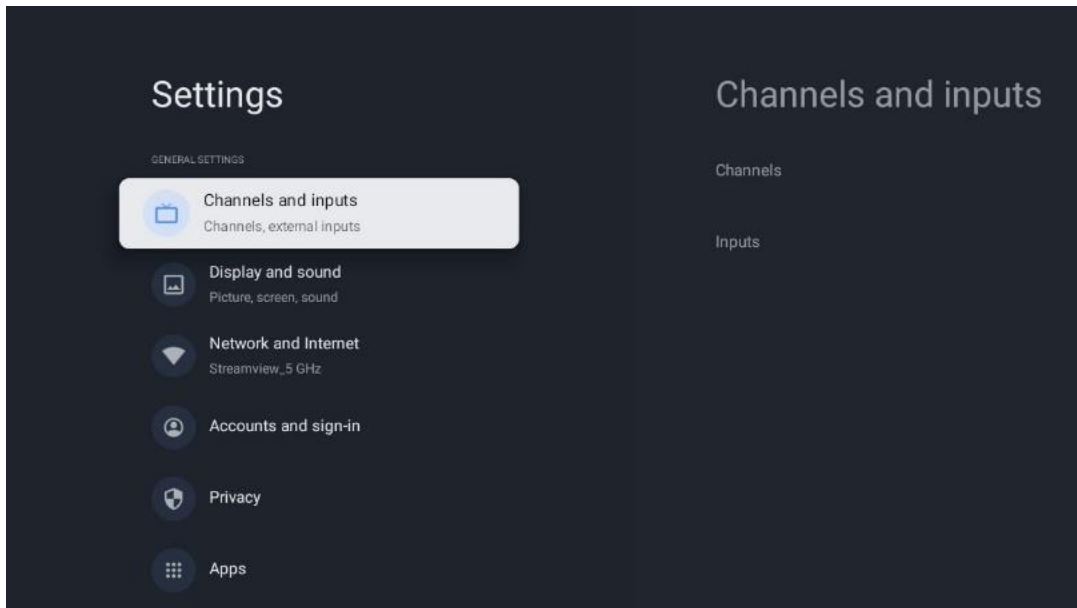

## 9.2.1 Channels

In this menu you can select the reception tuner installation mode according to your TV signal reception type: Analogue, Antenna, Cable or Satellite.

Select the mode and press **OK** to proceed to the tuning.

### 9.2.1.1 Analogue

- **Channel scan:** Press the **OK** button to perform the automatic search for Analogue channels. When the scanning process is finished, press the **Back** button to return to the previous Menu.
- **Update scan:** Press the **OK** button on the remote control to perform the automatic search to update the channel list. This will either add new channels or update information of current channels.
- **Analogue manual scan:** Press the **OK** button to manually choose a starting frequency and the direction of the scan.

### 9.2.1.2 Antenna

- **Channel scan:** Press the **OK** button on the remote control to perform the automatic search for DVB-T/T2 channels. When the scanning process is finished, press the **Back** button to return to the previous Menu.
- **Update scan:** Previously added channels will not be deleted, but newly found channels will be stored in the channel list.
- **Single RF scan:** Select the RF Channel by using the Right/Left directional buttons. Signal Level and Signal Quality of the selected channel will be shown. Press **OK** to start the scan on the selected RF channel. The found channels will be stored in the channel list.

- **Manual service update:** This function will start the update of the receivable TV/radio channels manually.
- **LCN:** Set your preference for LCN. LCN is the Logical Channel Number system that organizes available broadcasts in accordance with a recognizable channel number sequence (if available).
- **Channel scan type:** Set your scan type preference.
- **Channel store type:** Set your store type preference.
- **Favorite network select:** Select your favorite network. This menu option will be active, if more than one network is available.

### 9.2.1.3 Cable

- **Channel Scan:** The Smart TV searches for digital and analogue channels that can be received via cable. Depending on the country, optional DVB-C cable TV providers are offered during the initial installation and are listed on the Channel scan list screen. If you receive the DVB-C signal from a non-dedicated cable TV provider, select the option Others. Press **OK** to start the channel search. In the Channel scan menu, you can select one of the three channel search options: Full, Advanced, or Quick.
  - **Full:** Automatic search of all available DVB-C channels.
  - **Advanced:** Automatic search of all available DVB-C channels. For this option, it is necessary to enter the DVB-C provider's reception parameters, frequency and network ID. With this search option, the channels are sorted by LCN of the cable providers.
  - **Quick:** Automatic search for all available DVB-C channels. This will search all available cable transponders with the standard symbols.
- **Single RF scan:** Manual search of DVB-C channels by transponder frequency.
- **LCN:** LCN options for DVB-C channel search.
- **Channel scan type:** Set your scan type preference.
- **Channel store type:** Set your store type preference.

### 9.2.1.4 Satellite

First, you have to choose which channel installation mode to use.

#### Channel installation Mode - Preferred Satellite

- **Satellite re-scan:** The satellite search process will be performed again.
- **Satellite add:** This function is useful when the General Satellite option is selected as the TV signal type. When the Preferred Satellite option is selected, DiSEqC settings will be automatically determined and channels from new satellite providers will be added from new selected satellites, depending on the selected satellite provider.
- **Satellite update:** If you select the Scan function, the receivable satellites and the corresponding DiSEqC settings will be determined automatically, and new channels will be added.

- **Satellite manual tuning:** Select the satellite on which you want to perform the manual search of the satellite transponder on and press **OK**. Set the exact reception parameters of the desired satellite transponder (frequency, symbol rate and polarization). Make sure that the signal quality and signal level indicate a sufficient value and press the **Back** button. Press the Right directional button to start the search. The found programs will be saved at the end of the program list.

### **Channel installation Mode - General Satellite**

- **Satellite re-scan:** The satellite search process will be performed again. As an option, you can activate another receivable satellite and add it to the automatic search. Select another satellite and press **OK**. Set the exact reception parameters of the desired satellite, the DiSEqC connections and the reception parameters of a receivable satellite transponder (the frequency, the symbol rate, and the polarization). Make sure that the signal quality and signal level indicate a sufficient value and press the **Back** button. Press the Right directional button to start the scan. The found programs will be saved at the end of the program list.
- **Satellite add:** Press **OK** to set the reception parameters of the satellite you want to add. Activate the satellite in the satellite status and set the exact reception parameters of the desired satellite. Set the DiSEqC ports and the reception parameters of a receivable satellite transponder (the frequency, the symbol rate, and the polarization). Make sure that the signal quality and signal level indicate a sufficient value and press the **Back** button. Press the Right directional button to start the scan. The found channels will be stored at the end of the channel list.
- **Satellite update:** The channel scan of the selected satellites will be started, and new channels will be added to the channel list automatically.
- **Satellite manual tuning:** Select the satellite on which you want to perform the manual search of the satellite transponder on and press **OK**. Set the exact reception parameters of the desired satellite transponder (frequency, symbol rate and polarization). Make sure that the signal quality and signal level indicate a sufficient value and press the **Back** button. Press the Right directional button to start the search. The found programs will be saved at the end of the program list.

#### **9.2.1.5 Auto channel update**

This function enables automatic channel updates. By default, it remains deactivated. If you have individually sorted channels to maintain a specific order, it's advisable to keep this function disabled.

#### **9.2.1.6 Channel update message**

This function enables automatic channel updates. By default, it remains deactivated. Enable this function if you'd like to receive on-screen notifications when new channels become available.



### 9.2.1.7 Parental controls

This menu allows you to configure parental control options. To access it, you'll need to enter the PIN code you set during the initial TV setup process.

### 9.2.1.8 Open-source licenses

Here you will find information about Open-Source licenses.

## 9.2.2 Inputs

Here you will find information about devices connected to the HDMI inputs of your TV and the HDMI-CEC operation options.

**Connected input:** View the listed devices connected to the Composite or HDMI connections of your TV. You can rename the connection or assign an individual device name for specific connections.

**Standby inputs:** View a list of available HDMI inputs.

**Unconnected input:** View the connections to which no device is connected.

### Consumer Electronic Control (CEC)

With the CEC function of your TV, you can operate a connected device with the TV remote control. This function uses HDMI CEC (Consumer Electronics Control) to communicate with connected devices. Devices must support HDMI CEC and must relate to an HDMI connection. The TV comes with the CEC function switched on. Make sure that all CEC settings are properly set up on the connected CEC device. The CEC functionality has different names on different brands. The CEC function might not work with all devices. If you connect a device with HDMI CEC support to your TV, the related HDMI input source will be renamed with the connected device's name.

To operate the connected CEC device, select the related HDMI input source from the Inputs menu on the Home Screen. Or press the **Source** button if the TV is in Live TV mode and select the related HDMI input source from the list. To terminate this operation and control the TV via the remote again, press the **Source** button on the remote control and switch to another source.

The TV remote is automatically able to control the device once the connected HDMI source has been selected. However not all buttons will be forwarded to the device. Only devices that support the CEC Remote Control function will respond to the TV remote control.

**HDMI control On/Off:** Allow the TV to control HDMI devices.

**Device auto power Off:** Power Off HDMI devices with the TV.

**TV auto power on:** Power on the TV with HDMI device.

**CEC device list:** View the devices that support the HDMI function and are connected to your TV.

## 9.3 Display and sound

Adjust Picture, Screen, Sound and Audio output settings.

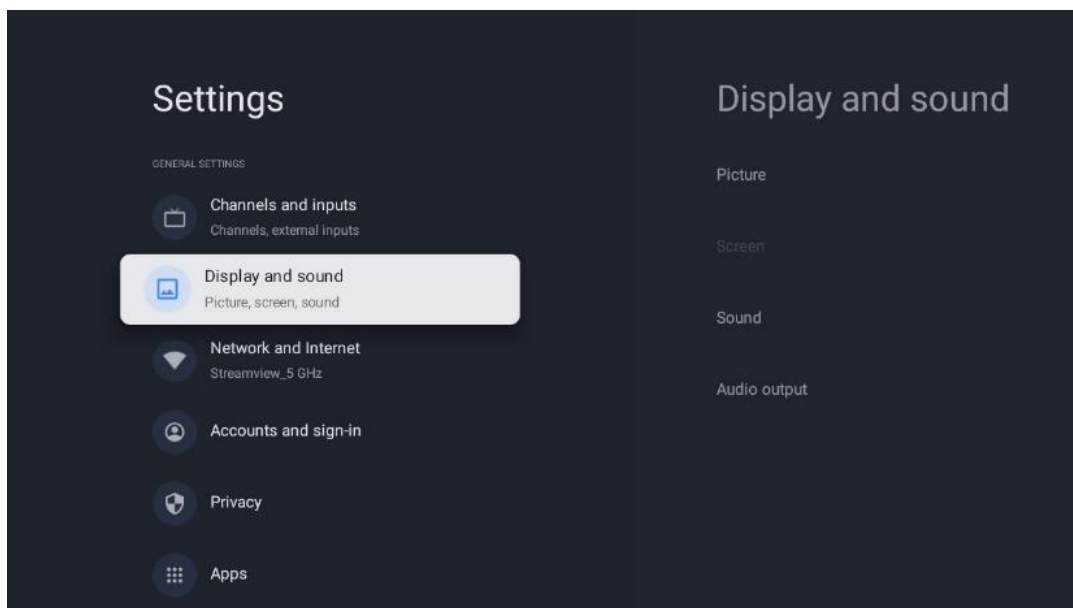

### 9.3.1 Picture

Here you can adjust Picture settings.

#### 9.3.1.1 Picture mode

In the initial installation of the TV, by default, the TV is set to Energy saving picture mode. Select one of the picture mode presets or you can manually adjust Picture settings to your preferences in User mode.

#### 9.3.1.2 User Mode (Manual picture adjustments)

Adjustments you can make:

- **Backlight**  
Changes the level of backlight, adjusting the level of illumination of the TV display panel
- **Auto brightness**  
When turned On, the TV adapts the brightness of its display in accordance with the brightness of the surroundings
- **Brightness**  
Changes the level of light emitted from the TV from darker to brighter
- **Contrast**  
Changes the level of contrast adjusting the picture luminating or the white brightness level, therefore, changing the brightness of all colors
- **Saturation**  
Changes the level of saturation, adjusting the intensity or vividness of colors on the

display

- **HUE**  
Changes the angular representation of the color values in an image. By adjusting the level, you remap the colors throughout an image
- **Sharpness**  
Changes the sharpness level, adjusting the edge enhancement

### 9.3.1.3 Advanced settings

- **Color Temperature:** Set your color temperature preference. User, Cool, Standard and Warm options will be available. You can adjust red, green and blue gain values manually. If one of these values is changed manually, the Color Temperature option will be changed to User, if it is not already set to User.
- **DNR:** Dynamic Noise Reduction (DNR) is the process of removing noise from digital or analogue signal. Set your DNR preference as Low, Medium, Strong or Auto, or turn it off.
- **MPEG NR:** MPEG Noise Reduction cleans up or blocks noise around outlines and noise on the background. Set your MPEG NR preference as Low, Medium or Strong, or turn it off.
- **Max vivid:** This option significantly increases the contrast, brightness and sharpness. You can either turn it on or off.
- **Adaptive luma control:** Adaptive Luma control adjusts contrast settings globally according to a content histogram to provide deeper black and brighter white perception. Set your Adaptive Luma Control preference as Low, Medium or Strong, or turn it off.
- **Local contrast control:** Local contrast enhancement attempts to increase the appearance of large-scale light-dark transitions, like how sharpening with an unsharp mask increases the appearance of small-scale edges.
- **Dynamic color booster:** Enhances the color display by adjusting the colorimetry to provide a more vivid and natural color representation.
- **Flesh tone:** The Flesh tone option allows you to refine the skin colors in pictures without affecting other colors on screen.
- **DI film mode:** It is the function for 3:2 or 2:2 cadence detection for 24 fps film contents and improves the side effects (like interlacing effect or judder) which are caused by these pull-down methods. Set your DI Film Mode preference as Auto or turn it off. This item will not be available if Game Mode or PC Mode (optional) is turned on.
- **Blue stretch:** The human eye perceives cooler white tones as brighter. The Blue Stretch feature changes the white balance of mid-high grey levels to cooler color temperatures. You can either turn this function on or off.
- **Gamma:** Set your gamma preference. Dark, Middle and Bright options are available.
- **Game mode:** Game mode is the mode which cuts down some of the picture processing algorithms to keep up with video games that have fast frame rates. Turn the Game Mode function on or off.
- **Color space:** Defines the spectrum of colors supported by the TV, influencing the richness and accuracy of color representation on the screen.

- **Color tuner:** Color saturation, hue and brightness can be adjusted by changing the red, green, blue, cyan, magenta, yellow and flesh tones (skin tone). This causes the image to appear more vivid or more natural. Set the hue, color, brightness, offset and gain values manually. Highlight Enable and press OK to turn this function on.
- **Point white balance correction:** The white balance feature calibrates the TV's color temperature in detailed grey levels. You can improve the grey scale uniformity either visually or by measuring it. Adjust the level of red, green, blue colors and gain values manually. Highlight Enable and press OK to turn this function on.

#### 9.3.1.4 Reset to default

Reset the picture settings to factory default settings.

**Note:** Depending on the currently set input source some menu options may not be available.

### 9.3.2 Sound

In this Menu you can adjust the sound settings.

#### 9.3.2.1 Sound style

For easy sound adjustment, you can select a preset setting. User, Standard, Vivid, Sport, Movie, Music, or News options are available. Sound settings will be adjusted according to the selected sound style.

#### 9.3.2.2 Manual sound adjustments

Alternatively, you can also make the following manual adjustments:

- **Sound style:** For easier sound adjustment, you can select a preset setting. User, Standard, Vivid, Sport, Movie, Music, or News options are available. Sound settings will be adjusted according to the selected sound style.
- **Balance:** Adjust the left and right volume balance for speakers and headphones.
- **Bass:** Adjust the level of low tones.
- **Treble:** Adjust the level of high tones.
- **Surround sound On/Off:** Activates the surround mode of the TV speakers.
- **Equaliser detail:** Sets the Equalizer parameters in User sound mode. Note: You can select one of the pre-installed sound modes offered in this menu or set Balance, Bass, Treble, Surround sound or Equaliser detail manually (only if Dolby Audio processing is deactivated).
- **Speakers On/Off:** Enable or disable TV speakers.
- **Speaker delay:** Here you can adjust the delay of the speaker sound.
- **Auto volume control:** With auto volume control, you can set the TV to automatically level out sudden volume differences, e.g. what is happening at the beginning of adverts or when you are switching channels. Select this option and press the OK button to turn it

on or off.

- **Downmix mode:** Set your preference to convert multi-channel audio signals to two-channel audio signals. Press OK button to see the options. Stereo and Surround options are available. Highlight the option you prefer and press the OK button to set.
- **Dialogue enhancer:** Automatically adjusts the sound of dialogues, making them stand out from other sounds.
- **Reset to default:** Resets the sound settings to factory defaults.

### 9.3.3 Audio output

**Digital output:** Set the digital sound output preference. Auto, Bypass, PCM, Dolby Digital Plus and Dolby Digital options are available. Highlight the option you prefer and press OK to set.

**Digital output delay:** Here you can adjust the delay of the SPDIF delay value.

## 9.4 Network & Internet

You can configure your TV's network settings using the options of this menu.

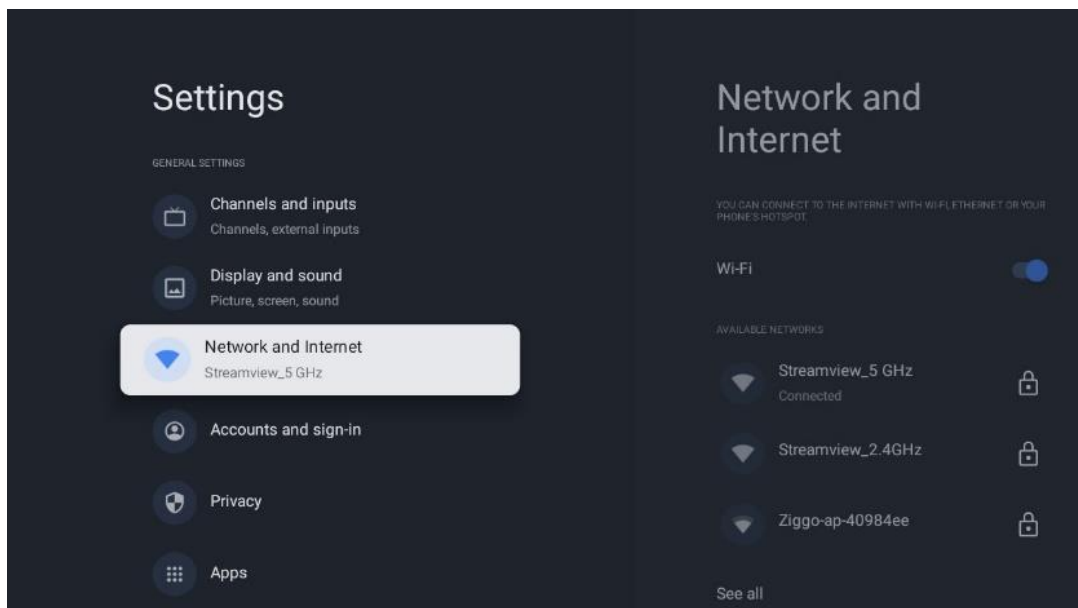

### 9.4.1 Wi-Fi On/Off

Turn the wireless LAN (WLAN) function on and off.

## 9.4.2 Choose available Wi-Fi network

When the Wi-Fi function is turned on, available wireless networks will be listed. Highlight See all and press **OK** to see all networks. Select one and press **OK** to connect. You may be asked to enter a password to connect to the selected network in case the network is password protected.

## 9.4.3 Other options

- **Add new network:** Add networks with hidden SSID's.
- **Data saver:** Automatically adjusts video quality to use fewer mobile data. It will monitor and limit your network traffic.
- **Data usage and alerts:** Showcases the amount of data used per day and allows you to set data alerts.
- **Scanning always available:** You can let the location service and other apps scan for networks, even when the Wi-Fi function is turned off. Press OK to turn it on and off.

## 9.4.4 Ethernet options

- **Connected / Not connected:** Displays the status of the internet connection via Ethernet, IP and MAC addresses.
- **Proxy settings:** Set a HTTP proxy for browser manually. This proxy may not be used by other apps.
- **IP settings:** Configure your TV's IP settings.

## 9.4.5 Others

Network privacy policy: Read about network privacy policy and accept or decline it.

Wake configs:

- **WoW:** Turn the Wake on WLAN function on and off. This function allows you to turn on or awaken your TV via wireless network.
- **WoL:** Turn the Wake on LAN function on and off. This function allows you to turn on or awaken your TV via network.

## 9.5 Accounts and sign-in

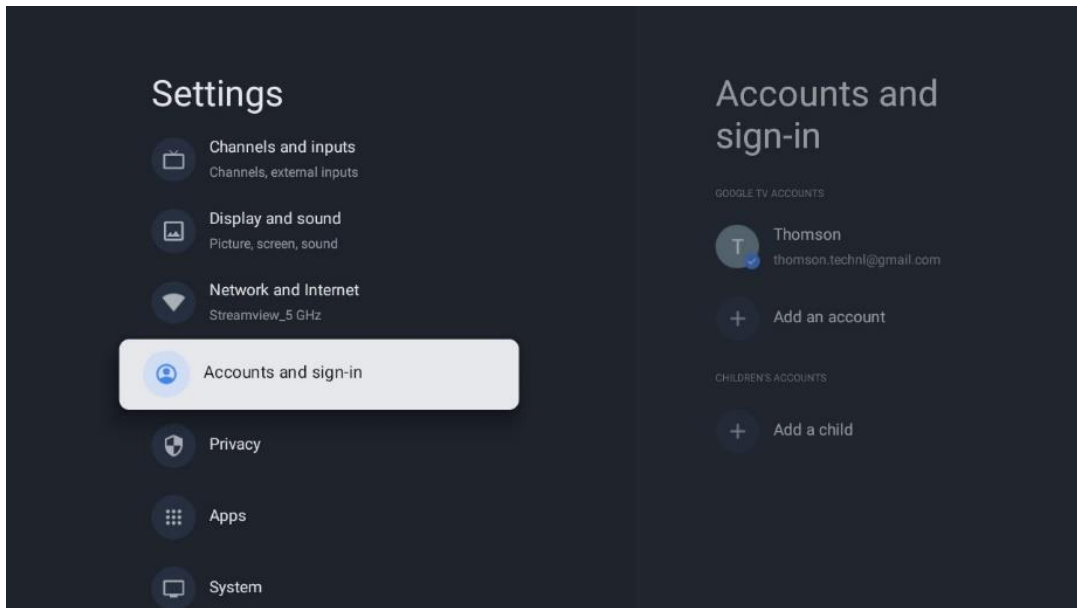

- **Google TV account:** This option will be available if you have signed in to your Google account. You can lock your account preferences, configure your data syncing preferences, manage your payments and purchases, adjust Google Assistant settings, enable Apps-only mode, and remove the account from your TV.
- **Add account:** Add a new account by signing in to it.
- **Add a child:** Add a child-friendly account with parental protection.

## 9.6 Privacy

Change and adjust your privacy settings and app permissions.

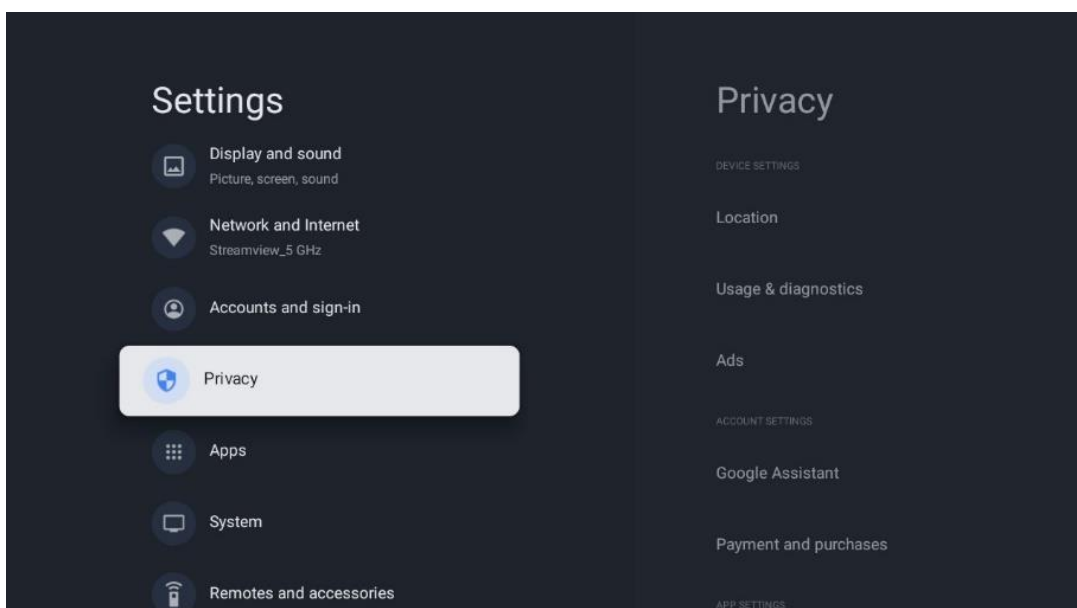

### Device settings:

- **Location:** Select whether Google may collect location data according to your Wi-Fi. It is important that you provide Google with your location because the installation of many applications depends on the Geo-location. Installation of certain streaming applications, especially those that stream TV broadcast channels, is only possible according to Geo-location rules.
- **Usage & diagnostic:** Automatically send diagnostic information to Google.
- **Ads:** Select whether Google is allowed to collect usage data and diagnostics and promote personalized ads to you.

### Account settings:

- **Google Assistant:** Select your active account, view permissions, select which applications should be included in the search results, activate the secure search filter and view the open-source licences.
- **Payment and purchases:** Setup Google Payment and Purchase settings.

### App settings:

- **Special app access:** Select which apps can have access to your information and have special access.
- **Security and restrictions:** You can use the options in this menu to allow or restrict the installation of apps from sources other than the Google Play Store. Set the options so that your TV does not allow or warns against the installation of apps that could cause serious issues.

## 9.7 Apps

Use the options in this Menu to manage the applications installed on your TV.

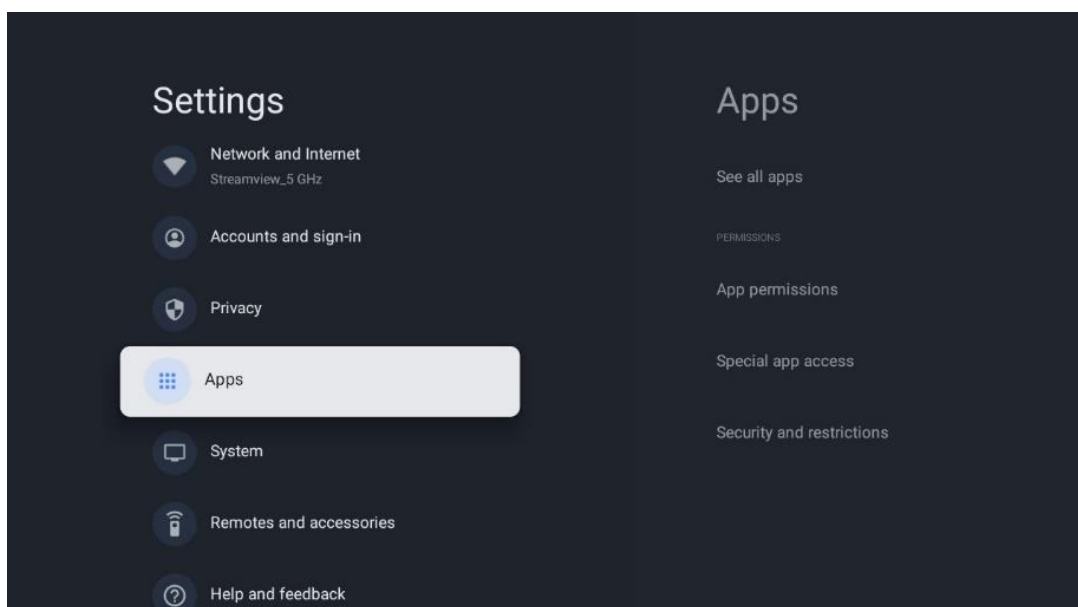



**Recently opened apps:** Recently opened apps are displayed here.

**See all apps:** Select See all apps and press OK to display a comprehensive list of all installed apps on your TV. You will also be able to see the storage space each App occupies. From there you can check App versions, start or force stop their operation, uninstall downloaded Apps, check permissions and switch them on or off, manage notifications, clear data and cache and much more. Simply highlight an App and press OK to access the available options.

**Permissions:** Manage the permissions and some other features of the apps.

- **App permissions:** The apps will be sorted by permission type category. You can enable/disable permissions for apps from within these categories.
- **Special app access:** Configure app features and special permissions.
- **Security & restrictions:** Using the options of this menu, you can allow or restrict installation of apps from sources other than the Google Play Store. Set the TV to disallow or warn before installation of apps that may cause harm.

## 9.8 System

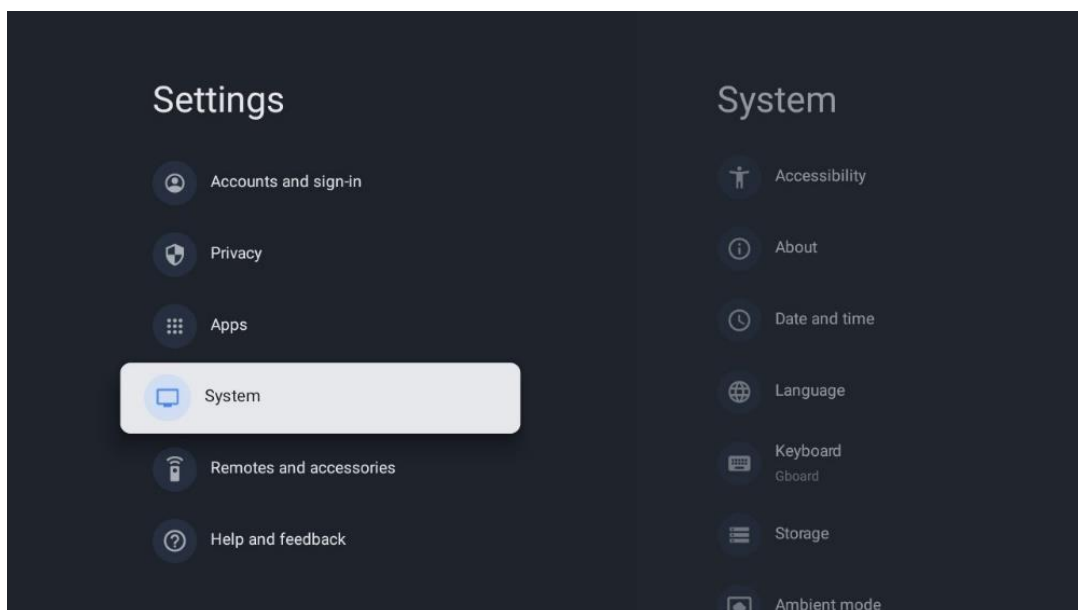

### 9.8.1 Accessibility

Turn on/off captions, adjust their language and text size and choose a caption style. Enable or disable high-contrast text.

Enable or disable Google's Text to speech function. This function will automatically voice text displayed on your screen. It is a useful function for people with eyesight problems. In this menu section you can adjust settings for Text to speech such as speech rate and default language.

## 9.8.2 About

Here you can find hardware and software information about your TV as well as the Android OS and the Netflix ESN version.

- **System update:** Select this Menu option and press **OK** on your remote control to check if a software update is available for your TV.
  - **Device name:** Select this Menu option and press **OK** on your remote control to change the name or assign a customized name for your TV. This is important because your TV should be correctly identified in your network or when performing the Chromecast function.
  - **Reset:** Select this Menu option to reset your TV to factory settings and reinstall your TV.
  - **Status:** In this Menu you will find the hardware information of your TV such as IP address, MAC address, Bluetooth address, Serial number and Uptime.
  - **Legal information:** In this menu you will find the Legal information of your TV.
  - **Model:** Shows you the model of your TV.
  - **Android TV OS version:** Shows you which OS version is installed on your TV.
- 
- **Android TV OS security patch level:** Shows the date of the security patch installed on your TV.

## 9.8.3 Date and time

Set the date and time on your TV. You can have this data updated automatically via network or via broadcasts. Set them according to your environment and preferences. Deactivate the Automatic date & Time option if you want to change the date or time manually. Then set the date, time, time zone and hour format options.

## 9.8.4 Language

Set the Menu language of your TV.

## 9.8.5 Keyboard

Select your virtual keyboard type and manage keyboard settings.

## 9.8.6 Storage

The total storage space status of the TV and the connected devices, if available, is displayed here. To view detailed usage information, highlight Internal storage partition or External storage connected device and press OK. Options for ejecting and formatting the connected storage devices are also displayed.

### 9.8.7 Ambient mode

Ambient mode on a TV is a feature that transforms the TV screen into a digital photo frame or virtual art display when not in use. You can manually start this mode in this menu section.

- **Channels:** Choose the source of photos or images to show in ambient mode.
- **More settings:**
  - Display the weather in C or F. You may choose to show both degree systems or hide degrees at all.
  - Display or hide time.
  - Adjust personal photos and Google Photos settings.
  - Adjust slideshow speed.

### 9.8.8 Power and energy

**Power-on behavior:** Choose whether you want to see the Google TV home screen or the last used input source after your TV has turned on.

**Energy saver:** Adjust the time of inactivity, after which the TV turns itself off automatically.

#### Power:

- **Sleep time:** Set a time after which the TV switches off and goes into standby mode automatically.
- **Picture off:** Select this option and press **OK** to turn the screen off. Press any button on the remote control or on the TV to turn the screen on again. While the TV screen is switched off, you can still perform basic operations such as Volume +/-, Mute and Standby with the remote control. These functions work independently of the On/Off operation of the TV screen.
- **Switch off Timer:** Set a time after which the TV switches off automatically.
- **Auto sleep:** Set after what period of inactivity the TV should automatically switch to standby mode.
- **Standby light:** Turn On/Off standby light on your TV.

#### Timer:

- **Power on time type:** Set your TV to turn on by itself. Set this option as On or Once to be able to set a power on timer, set as Off to disable. If set as Once the TV will turn on only once at the time you defined in the Auto Power On Time function.
- **Auto power on time:** Available if the Power On Time Type is enabled. Set the desired time for your TV to turn off standby mode using the directional buttons and press **OK** to save the set time.
- **Power off time type:** Set your TV to turn off by itself. Set this option as On or Once to be able to set a power off timer, set as Off to disable. If set as Once the TV will turn off only once at the time you defined in Auto Power Off Time function.
- **Auto power off time:** Available if the Power Off Time Type is enabled. Set the desired

time for your TV to go into standby using the directional buttons and press **OK** to save the set time.

### 9.8.9 Cast

When running the Chromecast function from the mobile device that is in the same network as your TV, your TV will be recognized as a Google Cast device and allows the Google Assistant and other services to wake up your TV and respond to connected Chromecast devices. It will be possible to stream content or local multimedia content from your mobile devices to your TV.

Select your preference for Chromecast availability. You have three setting options:

**Always** - your TV will always be visible to other devices that support this feature (even if it is in standby mode and the screen is switched off).

**While casting** - Your TV will only be visible while using the Chromecast function.

**Never** - Your TV will not be visible to other devices.

### 9.8.10 Google

Check whether there are any system service updates available.

### 9.8.11 System sounds

Activate or deactivate the system sounds.

### 9.8.12 Retail mode

Activate or deactivate Retail (Shop) mode of the TV.

### 9.8.13 Restart

Restart your TV.

## 9.9 Remote and accessories

Connect your Bluetooth devices such as a soundbar, headphones, Bluetooth speakers, mouse & keyboard, or a game controller to your TV.

- Set the device you want to connect to pairing mode.
- Select the Pair accessory Menu option and press the **OK** button on the remote control to start the search for Bluetooth devices in pairing mode.
- The available devices will be recognized and displayed in a list.
- Select the desired device from the list and press **OK** to start the pairing process with the TV.
- When the pairing process is completed, Bluetooth connected devices will be listed under accessories.

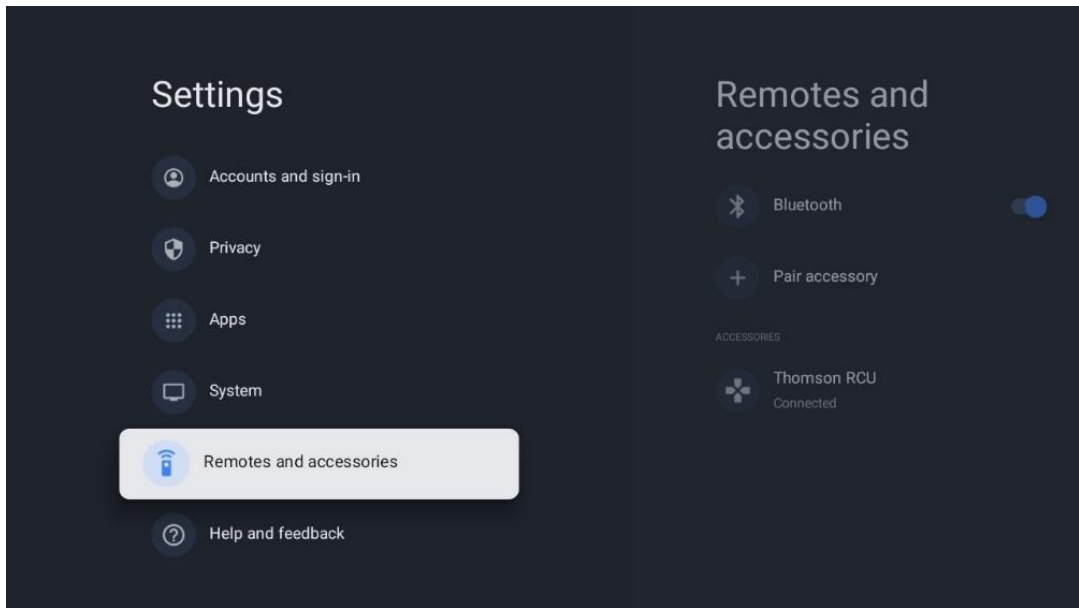

## 10 MMP – Multimedia Player

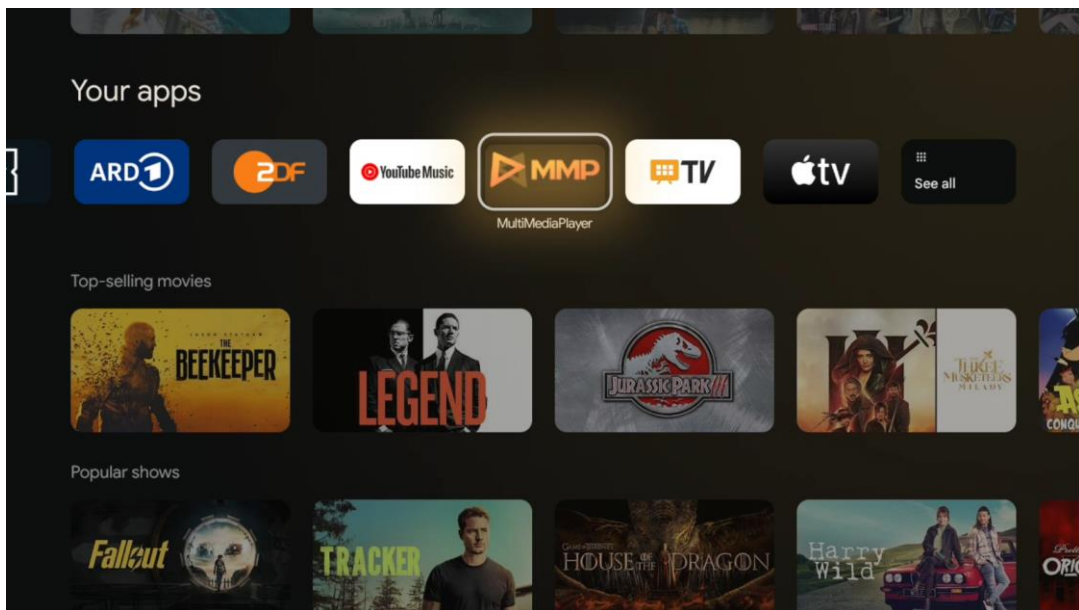

Playback of multimedia data from external storage devices

Plug the USB storage device into one of the USB inputs on the TV to view your photos, play your music, or watch video files stored on the connected USB storage device.

To begin, start the MMP application from your Home screen and select the desired media type. Navigate to the file you want to open and press the **OK** button. Follow the on-screen instructions for more information on other available button functions.

To play multimedia files from external USB storage devices, you can also use any of the multimedia players available for download in the Google Play Store.

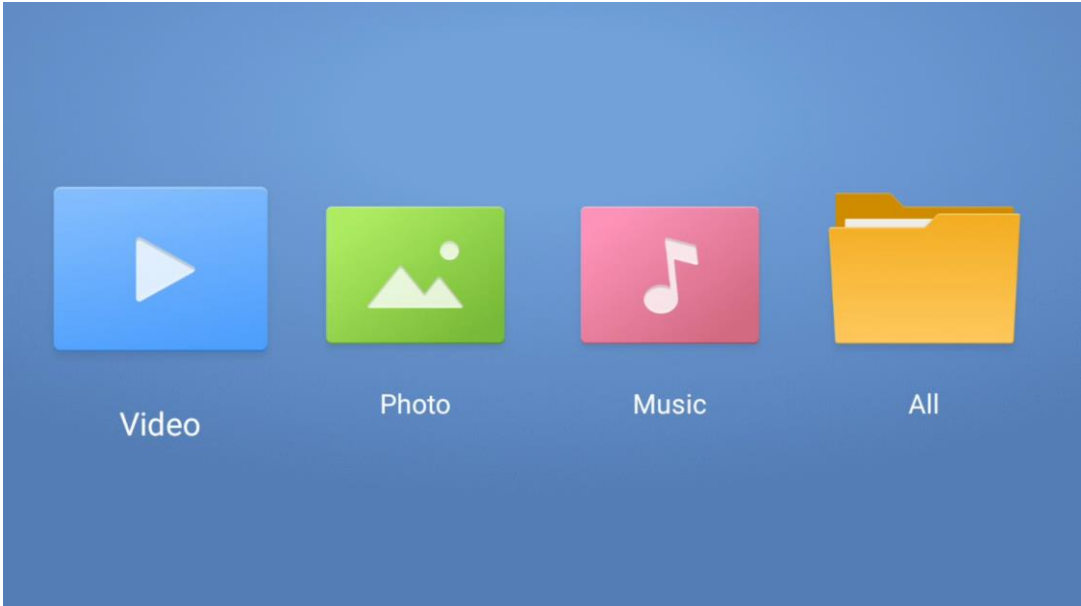

**Note:**

- Depending on the storage capacity of your connected USB device, it may take several seconds before your files are listed. Do not remove your drive while playing a file.
- Storage capacities larger than 2 TB are not supported.
- The TV only recognizes external storage devices formatted in **FAT32 or NTFS** file systems. In order to format the external storage device, use your laptop or PC.

## Live TV settings

Select the Live TV app on the Home screen and press the OK button to launch it.

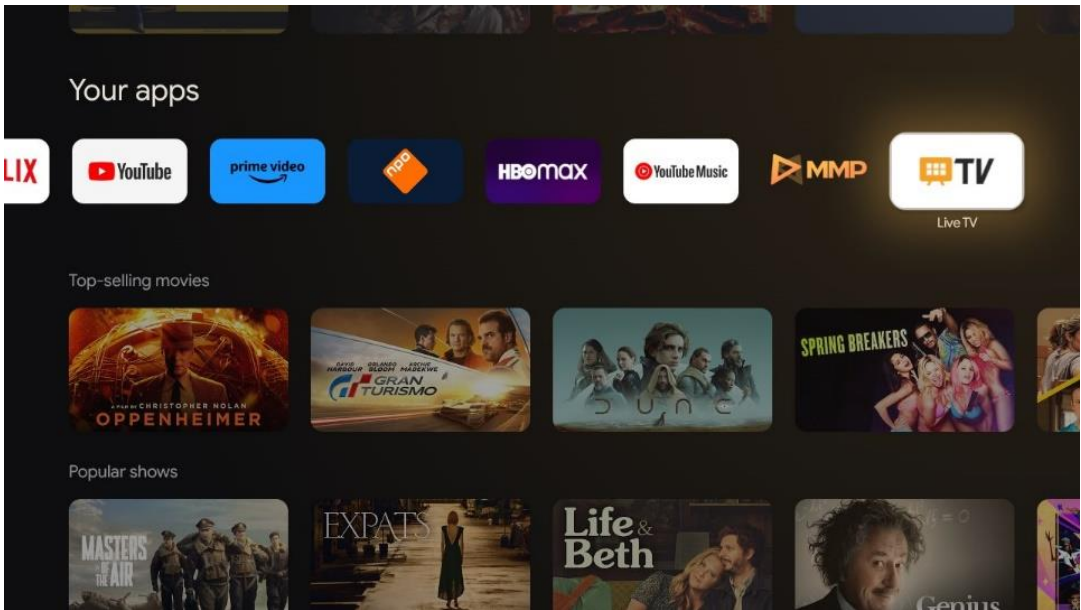

If you have not installed the Live TV broadcast channels in the initial installation process, but would like to do so, follow one of these steps:

- Go to the Home Screen, navigate to the top right corner and press the Settings icon. Go to Channels and Inputs. For more information go to chapter 9.2.
- Go to the Home Screen and open the Live TV app in Your Apps. Press the **Settings** button on your remote control to open an optional menu. Navigate to Settings and press **OK**. This opens the main TV Settings. Go to Channels and Inputs. For more information go to chapter 9.2.

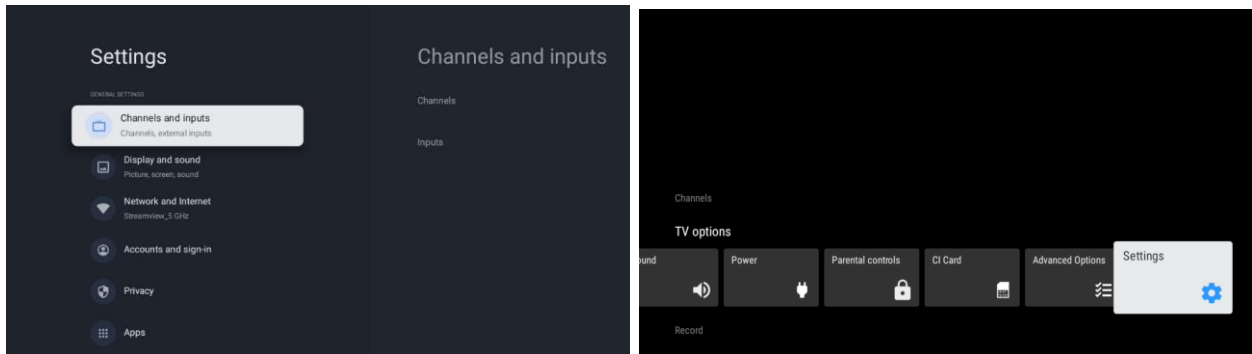

Refer to 9.2 Channels and Inputs to proceed with channels installation.

## 11 LIVE TV

Open the Live TV app. Press the **Settings** button on your remote control to open the optional menu. The following options are available: Channels and TV options.

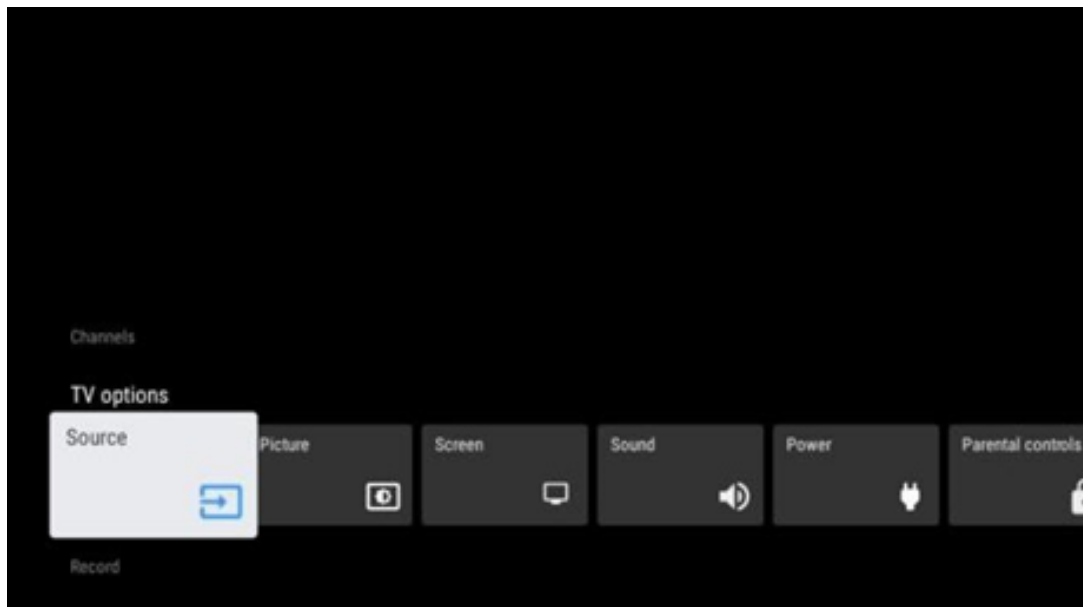

## 11.1 Channels

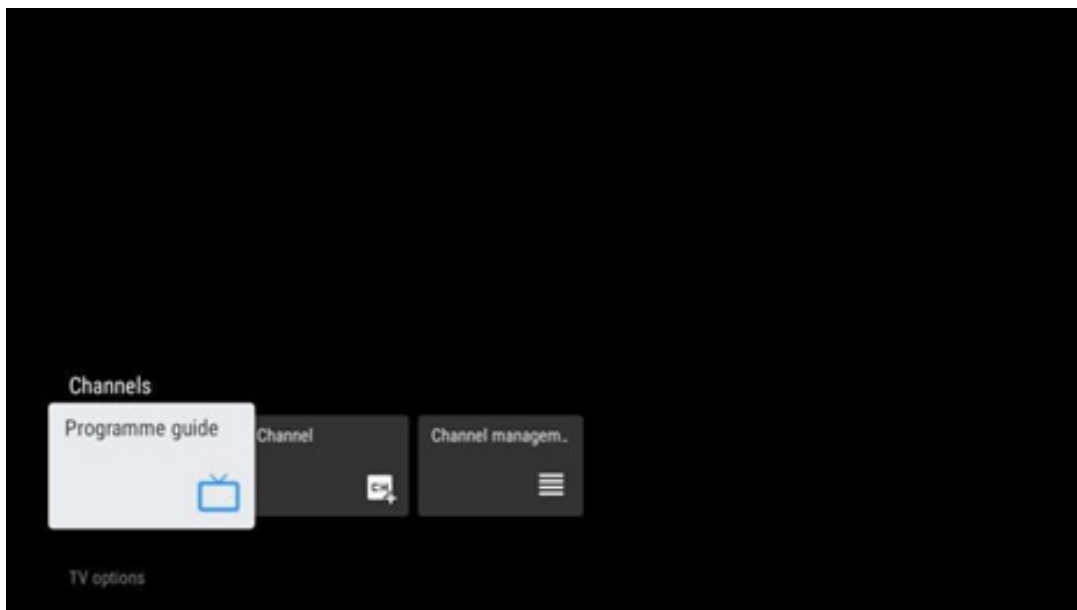

### 11.1.1 Electronic Program Guide (EPG)

Experience the convenience of the Electronic Program Guide (EPG) feature on your TV, enabling you to effortlessly browse the schedule of channels currently available in your channel list. Please note, the availability of this function depends on the program.

To access the electronic program guide while in Live TV mode, simply select this corresponding menu option or press the **EPG** button on your remote control. To return to Live TV, press the **Back** button on your remote control.

Navigate through the program guide using the directional buttons on your remote control. Utilize the Up/Down directional buttons or the Program +/- buttons to browse through channels, and the Right/Left directional buttons to select a desired event on the highlighted channel. Detailed information such as the full event name, start and end time, date, genre, and a brief description will be displayed at the bottom of the screen if available.

Easily filter events by pressing the blue button on your remote control, offering a variety of filter options to quickly locate events of your preferred type. For more information about a highlighted event, press the yellow button to display detailed information.

To view events from the previous or next day, simply press the red or green buttons respectively. These functions are assigned to the colored buttons on your remote control if available. Refer to the on-screen instructions for the specific functions of each button.

Please note that the guide will not be accessible if the TV input source is locked. You can lock/unlock the input source by going to Settings > Channel > Parental Controls > Locked Inputs either in Live TV mode or on the home screen.



## 11.1.2 Channel

Select the Live TV signal reception type to which your TV is connected to.

## 11.1.3 Channel management

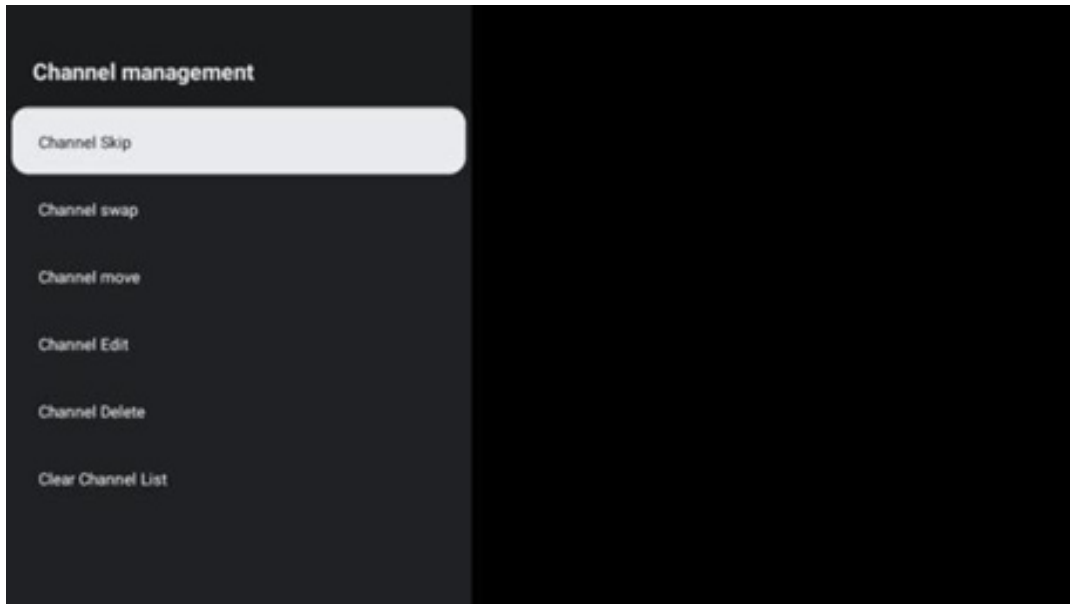

To edit channel list, first make sure LCN function is disabled in the channel settings menu. This can be done in the Channel menu along with other channel management options.

- Open LiveTV app.
- Press **OK** to open the Channel list.
- Press the red button to open the Channel management.

Follow the following steps to edit the channels:

### Channel SKIP

Once a channel is set to be skipped, it will no longer appear in the channel list or program guide, even after restarting the TV, but the channel is not deleted.

- Select Channel Skip.
- Select the channels which you want to SKIP.

### Channel SWAP

Switch the position of channels in the channel list.

- Select Channel Swap.
- Select the channel which you want to SWAP (for example, channel 1).
- Select the channel that you want to switch its position with (for example, channel 16).
- Confirm by pressing the **OK** button.

### Channel MOVE

Rearrange the position of channels in the channel list.

- Select Channel Move.
- To change the channel position, select the channel that you want to MOVE (for example, channel 1).
- Move it to the number where you want the channel to be moved to (for example, channel 5)
- After selecting the position, press the blue button on your remote - a Warning message will appear.
- Select YES and press **OK** on your remote. The channel will be moved to the desired position.

### **Channel EDIT**

Customize and manage the channels stored on your TV.

- Select Channel EDIT.
- Select the channel that you want to EDIT (for example, channel 1).
- Now you have the option to edit the number of the channel and the channel name.

### **Channel DELETE**

Remove unwanted channels from the channel list. Note that in order to display previously deleted channels again, you will have to perform a channel scan.

- Select Channel Delete
- Select the channel that you want to Delete (for example, channel 5).
- Press the blue button on your remote - a Warning message will appear.
- Select YES and press **OK** on your remote control. The channel will be deleted from the list.

### **Channel RE-SORT**

Reorder the whole channel list. If there is a Logical Channel Number (LCN) from your provider, then the channels will be reordered according to LCN.

### **Clear channel list**

Clear the whole channel list. When completed, you will have to scan for channels again. To check how to do it, please, refer to 9.2.

## 11.2 TV Options

The following options are available: Source, Picture, Screen, Sound, Power, Parental controls, CI card, Advanced Options and Settings.

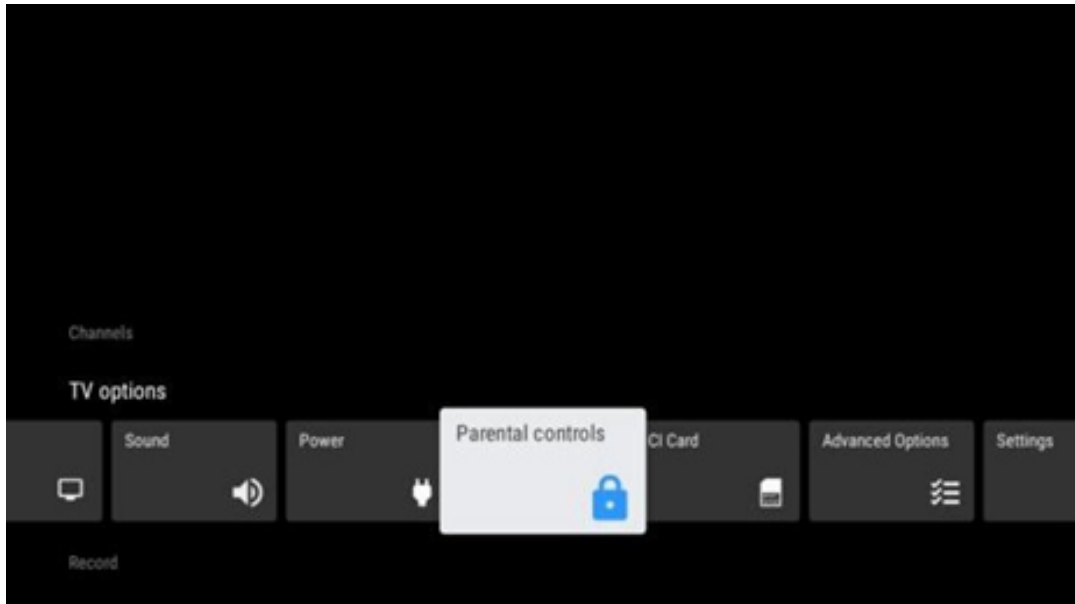

### 11.2.1 Source

Display the list of available input sources. Select the desired one and press **OK** to switch to that source.

### 11.2.2 Picture

Open the picture settings. How to adjust these settings, refer to 9.3.1.

### 11.2.3 Screen

Open the screen aspect ratio adjustments. Adjust these settings until you feel comfortable watching TV.

### 11.2.4 Sound

Open the sound settings. How to adjust these settings, refer to 9.3.2.

### 11.2.5 Power

Open the power and energy settings. How to adjust these settings, refer to 9.8.8.

## 11.2.6 Parental controls

Configure the parental control options. To access it, you'll need to enter the PIN code you set during the initial TV setup process.

## 11.2.7 CI card

Display the available menu options of the connected CI cam/card.

## 11.2.8 Advanced options:

- **Audio:** Adjust your audio preferences such as audio language, second audio language, soundtrack settings and audio type. Selecting the preferred audio language is particularly important for TV channels that broadcast in several languages.
- **Subtitle:**
  - Analogue Subtitle: Set this option as Off, On or Mute. If Mute option is selected, the analogue subtitle will be displayed on the screen, but the speakers will be muted simultaneously.
  - Digital Subtitle: Set this option as Off or On.
  - Subtitle Tracks: Set your subtitle track preference, if available.
  - Digital Subtitle Language: Set one of the listed language options as first digital subtitle language preference.
  - Second Digital Subtitle Language: Set one of the listed language options as second digital subtitle language preference. If the selected language in the Digital Subtitle Language option is not available, the subtitles will be displayed in this language.
  - Subtitle Type: Set this option as Normal or Hearing Impaired. If Hearing Impaired is selected, it provides subtitles with additional descriptions for deaf and hearing-impaired viewers.
- **Teletext:**
  - Digital Teletext Language: Set the teletext language for digital broadcasts.
  - Decoding Page Language: Set the decoding page language for teletext display.
- **Blue mute:** When enabled the screen color will change to blue when there is no signal detected on a particular input or channel.
- **No signal auto power off:** Set the time after which the TV goes into Standby mode, provided there is no signal.
- **Default channel:** Set your default startup channel preference. When the Select Mode is set to User Select, the option Show Channels will become available. Highlight and press **OK** to see the channel list. Highlight a channel and press **OK** to select it. Selected channels will be displayed every time the TV is turned back on from quick standby mode. If the Select Mode is set as Last Status, the last watched channel will be displayed.
- **HBBTV settings:** Enable or disable HBBTV support, choose tracking options, adjust cookie settings or adjust device ID settings.

- **System information:** Display detailed system information on the current channel such as Signal Level, Signal Quality, Frequency etc.
- **Open-source licenses:** View all information regarding licenses.

## 11.2.9 Settings

The Settings Menu is explained in detail in Menu chapter 9 of this User Manual.

## 12 Channel list option

To open the Channel list, open Live TV and press **OK**. You will be able to see the channel list defined by LCN, if this option is enabled.

Some options in the Channel list:

You can select Channel management, Channel operation, Select Type and Add favorite by pressing the colored button on your remote control.

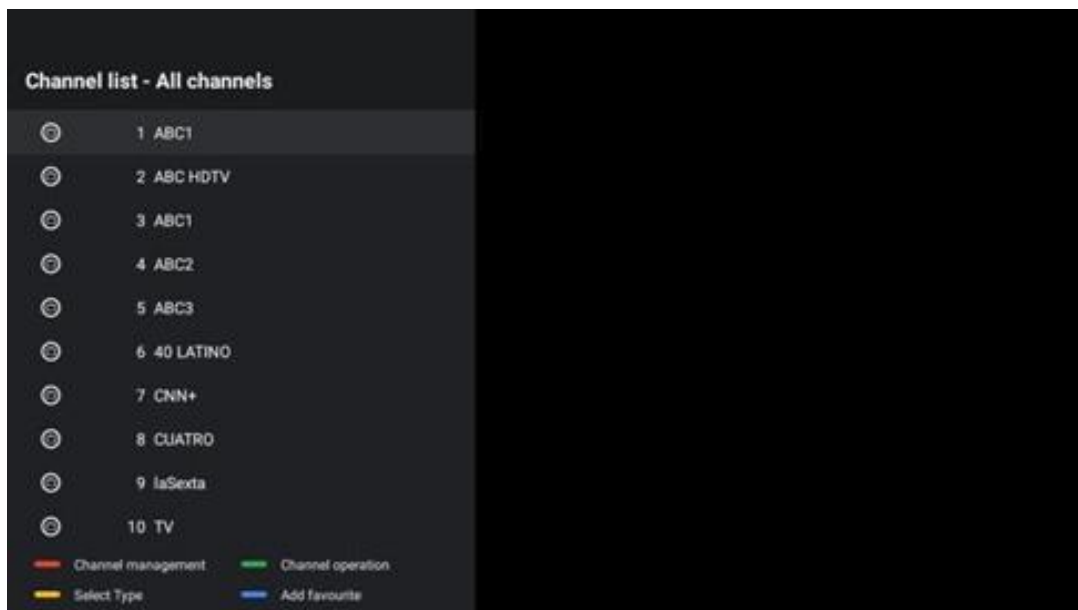

### 12.1 Channel operation

By pressing the green button, you can sort or find channels.

Available sorting options are Default, Name up, Name down, Encrypted, DTV/DATA/RADIO or HD/SD.

Select your preferred way of sorting by pressing **OK** on your remote control.

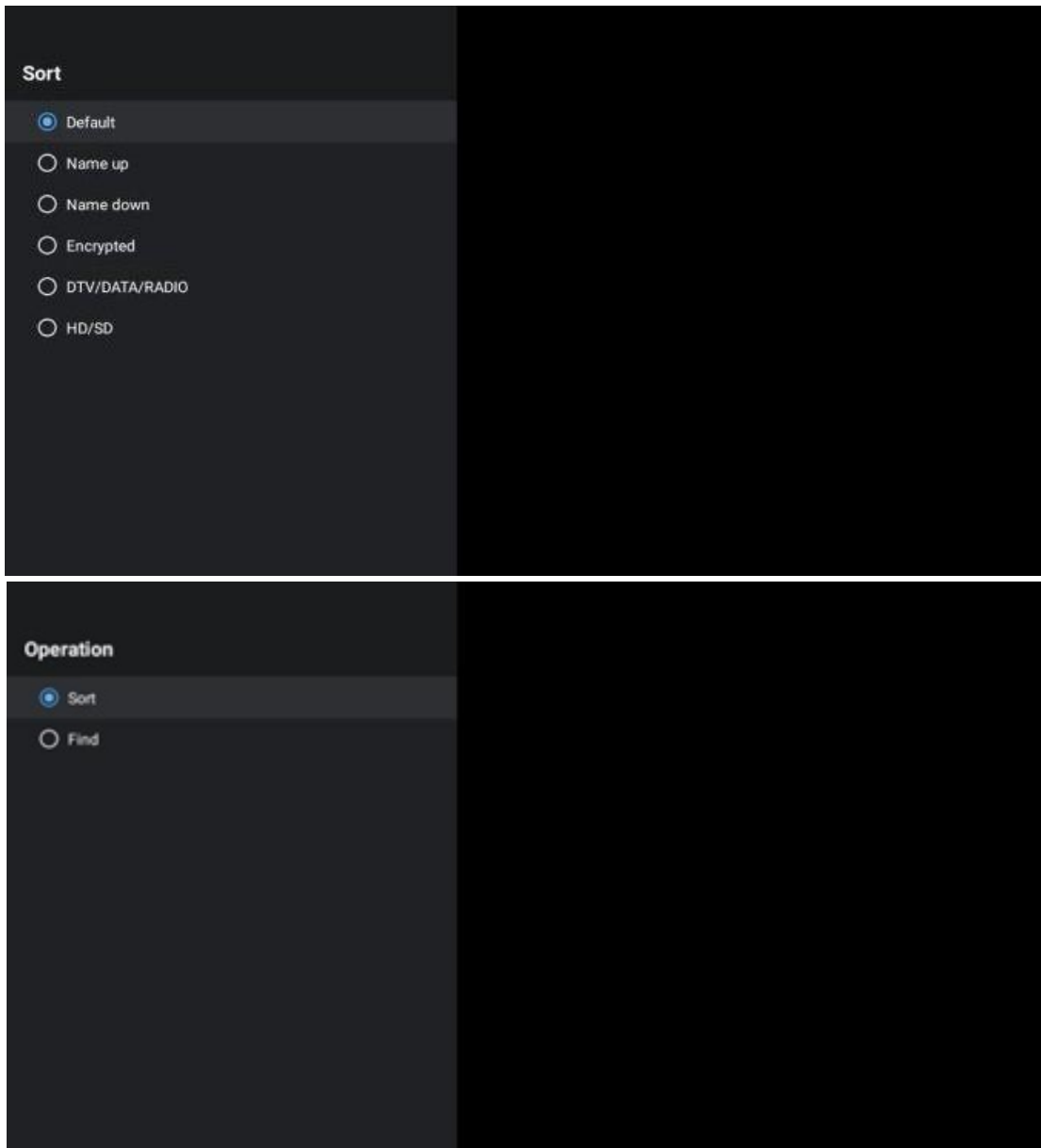

## 12.2 Select type

By pressing the yellow button, you can decide what type of media to show in Live TV.

Available options are: All channels, TV, Radio, Free, Encrypted or Favorites.

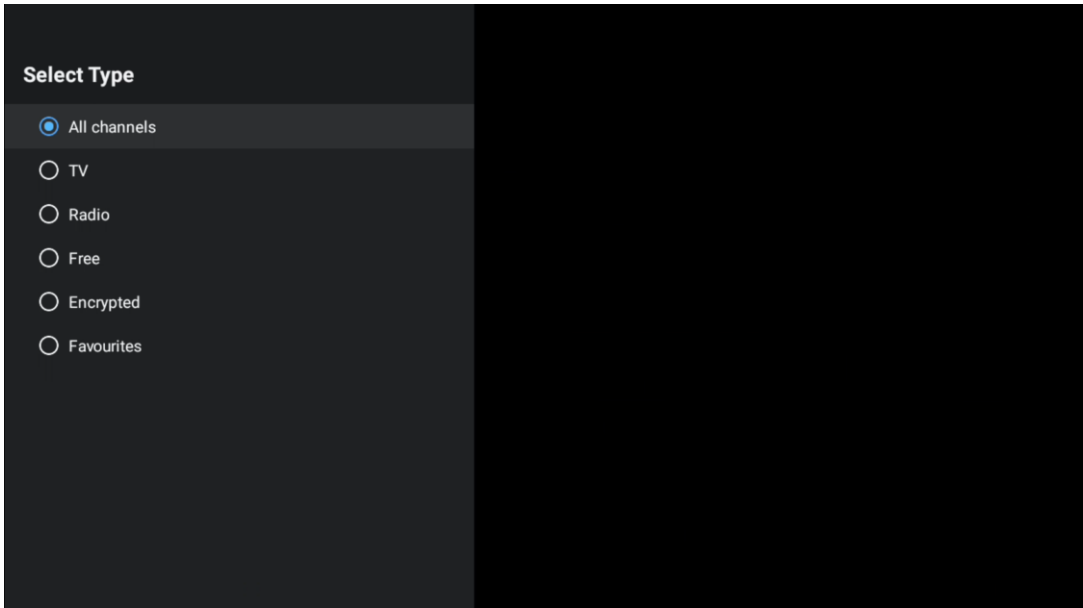

## 12.3 Add favorite

Create favorite lists and add your preferred channels to it. Note: You only have four favorite lists available. To add a favorite channel to a list, go to Select type and select Favorites. Then select the list that you want to watch.

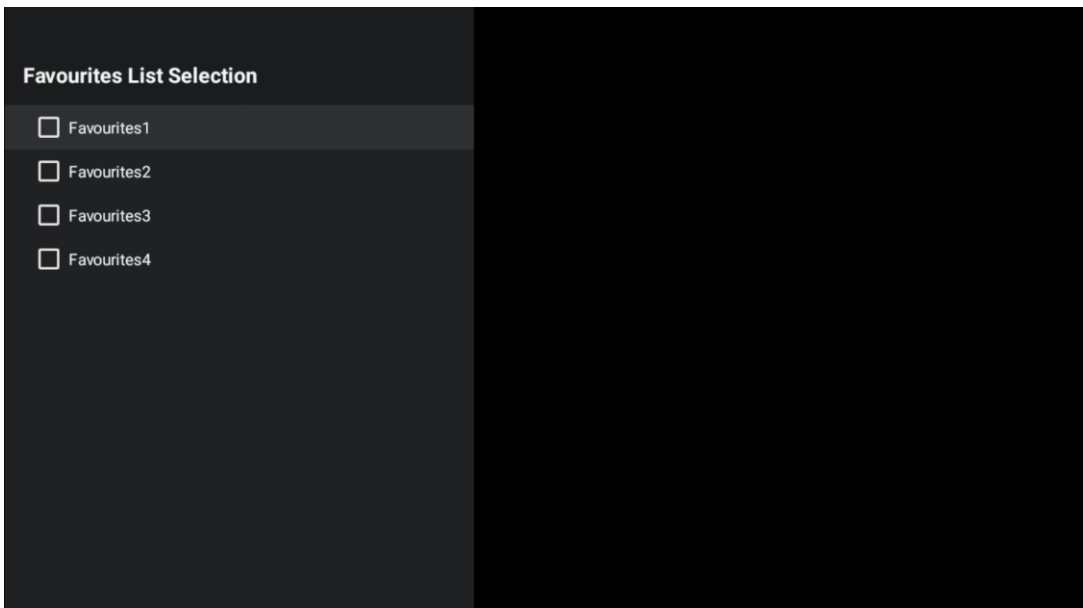

## 13 Troubleshooting

No power	Check if the AC power cord of your TV is plugged in or not. If there is still no power, please disconnect the plug and reconnect to the socket after 60 seconds. Turn the power back on.
No picture	Check if the antenna cable at the back is connected properly. View other channels to see if the problem still occurs.
Video appears with no audio	Try to increase the volume. Check if the TV's sound is on mute or not.
Remote doesn't work	Make sure the plastic bag which came with the remote control is removed. Try using the remote in a shorter distance from the TV. Check if the placement of the batteries is correct or try using new batteries with the remote control. The TV will go into Standby mode if it receives no response within a few minutes.
Problems are unresolved	Unplug the power cable and wait for 30 seconds, then reconnect power cable to the socket. If the problems still exist, do not attempt to repair the TV by yourself. Kindly contact the service center.

## 14 Technical specifications

	24HG2S14C/ 24HG2S14CW/ 24HQG4S14C	32HG2S14/ 32HG2S14W	32FG2S14/ 32QG4S14	32FG2S14C/ 32QG4S14C	40FG2S14/ 40FG2S14W/ 40QG4S14	43FG2S14/ 43FQG4S14
Operating Voltage	100-240 V, 50-60 Hz	100-240 V, 50-60 Hz	100-240 V, 50-60 Hz	100-240 V, 50-60 Hz	100-240 V, 50-60 Hz	100-240 V, 50-60 Hz
DC Adapter Specifications (Output)	12 V/3A, 36W			12 V/4A, 48W		
Audio (DTS HD)	no	no	no	no	no	no
Audio Output Power	2 x 3	2 x 8	2 x 8	2 x 8	2 x 8	2 x 8
Power Consumption (W)	36	56	56	48	90	90
Networked Standby Power Consumption (W)	< 0,5	< 0,5	< 0,5	< 0,5	< 0,5	< 0,5
Weight (Kg)	2.25	3.35	3.35	3.35	5.4	6.1
TV Dimensions LxWxH (with stand) (mm)	535 x 151 x 353	719 x 151 x 456	719 x 151 x 456	719 x 151 x 456	892 x 172 x 559	955 x 172 x 590
TV Dimensions LxWxH (without stand) (mm)	535 x 75 x 318	719 x 82 x 423	719 x 82 x 423	719 x 82 x 423	892 x 84 x 509	955 x 85 x 555
Display	24"/60 cm	32"/80 cm	32"/80 cm	32"/80 cm	40"/101 cm	43"/109 cm
Screen resolution	1366x768	1366x768	1920x1080	1920x1080	1920x1080	1920x1080

### 14.1 Country restrictions

Intended for indoor use only.

AT	BE	BG	CH	CY	CZ	DE	DK	EE	ES	FI	FR
GR	HR	HU	IE	IS	IT	LI	LT	LU	LV	MT	NL
NO	PL	PT	RO	SI	SK	SE	TR	UK	(NI)		



## 14.2 Licenses

Subject to alterations. In consequence of continuous research and development technical specifications, design and appearance of products may change. Google, Google Play, Android TV, Google Cast and other marks are trademarks of Google LLC. Google Assistant is not available in certain languages and countries. Availability of services varies by country and language. Netflix is a registered trademark of Netflix, Inc. Netflix streaming membership required (Un abonnement Streaming Netflix est requis). Apple TV is a trademark of Apple Inc., registered in the U.S. and other countries and regions. Wi-Fi is a registered trademark of Wi-Fi Alliance®. The terms HDMI and HDMI High-Definition Multimedia Interface, and the HDMI logo are trademarks or registered marks of HDMI Licensing Administrator, Inc. in the United States and other countries. Manufactured under license from Dolby Laboratories. Dolby, Dolby Audio, and the double-D symbol are trademarks of Dolby Laboratories Licensing Corporation. All rights reserved. All product names are trademarks or registered trademarks of their respective owners. ©2025 StreamView GmbH, Franz-Josefs-Kai 1, 1010 Vienna, Austria. This product has been manufactured and sold under the responsibility of StreamView GmbH. THOMSON, and the THOMSON logo are trademarks used under license by StreamView GmbH – further information at [www.thomson-brand.com](http://www.thomson-brand.com).